

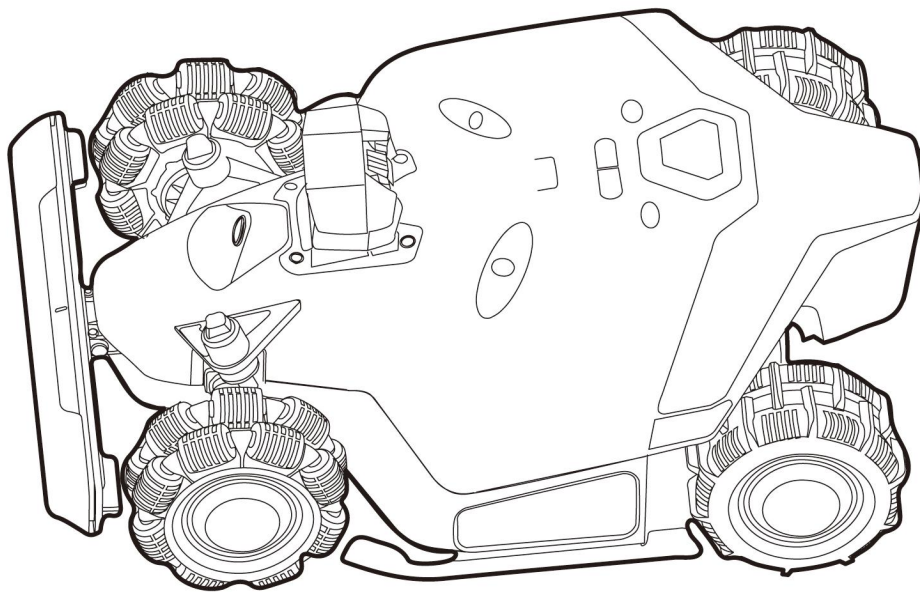

Mammotion Technology

USER MANUAL

LUBA 2 AWD SERIES



Original Instructions
Version **V5.0**
2024.07

Thank you for choosing Mammotion as your garden care lawn mower. This user manual will help you learn and operate Mammotion Luba, a 4-wheel-drive and perimeter-free lawn mower, to cut grass and maintain your lawn.

This manual is copyrighted by Mammotion Tech company. Without the written permission of the company, any unit or individual shall not copy, modify, reproduce, transcribe or transmit in any way or for any reason.

This manual is subject to change without notice at any time.

Revision Log

| Date | Version | Description |
|----------------|----------------|--|
| 2024.01 | V1.0 | Initial version |
| 2024.02 | V2.0 | <ol style="list-style-type: none">1. Chapter 4 updated2. Section 4.5.3 updated3. Sections 4.5.9 updated4. Section 5.1 updated |
| 2024.04 | V3.0 | <ol style="list-style-type: none">1. Section 2.1.7 added2. Chapter 4 updated3. Section 4.8.3 added4. Chapter 6 updated5. Chapter 7 updated |
| 2024.06 | V4.0 | <ol style="list-style-type: none">1. Section 2.1.5 added2. Section 3.4.6 added3. Chapter 4 updated4. Section 4.6.1 added5. Chapter 5 added |
| 2024.07 | V5.0 | <ol style="list-style-type: none">1. Section 2.1.5 updated2. Section 2.1.7 updated3. Section 4.6.1 updated4. Section 4.6.2 updated5. Section 4.6.5 updated6. Section 4.7 updated7. Section 4.8 updated |

CONTENTS

| | |
|---|---------------|
| 1 Safety Instructions | - 1 - |
| 1.1 General Safety Instructions | - 1 - |
| 1.2 Safety Instructions for Installation | - 2 - |
| 1.3 Safety Instructions for Operation | - 2 - |
| 1.4 Battery Safety | - 3 - |
| 1.5 Residual Risks | - 3 - |
| 2 Introduction | - 4 - |
| 2.1 About Mammotion Luba | - 4 - |
| 2.2 In the Box | - 9 - |
| 2.3 Symbols on the Product | - 12 - |
| 2.4 Product Overview | - 14 - |
| 3 Installation | - 17 - |
| 3.1 Preparation | - 17 - |
| 3.2 Choosing a Location for RTK Reference Station | - 17 - |
| 3.3 Choosing a Location for Charging Station | - 20 - |
| 3.4 Installing | - 21 - |
| 4 Operation | - 33 - |
| 4.1 Preparation | - 33 - |
| 4.2 Download Mammotion App | - 33 - |
| 4.3 Mammotion Account Sign-up and Login | - 34 - |
| 4.4 Add Your Robot | - 37 - |
| 4.5 Main Page Introduction | - 39 - |
| 4.6 Map Page Introduction | - 41 - |
| 4.7 Service | - 71 - |
| 4.8 Me | - 72 - |
| 5 Maintenance | - 77 - |
| 5.1 Maintenance for Motors and Cutting Blades | - 77 - |
| 6 Product Specifications | - 78 - |
| 6.1 Technical Specifications | - 78 - |
| 6.2 LED Indicator Codes | - 81 - |
| 6.3 Fault Codes | - 83 - |
| 7 Warranty | - 85 - |
| 8 Compliance | - 87 - |

1 Safety Instructions

1.1 General Safety Instructions

- Carefully read and understand the user manual before using the robot.
- Only use the equipment recommended by Mammotion with the robot. Any other usage is incorrect.
- Never allow children, persons with reduced physical, sensory or mental capabilities or lack of experience and knowledge or people unfamiliar with these instructions to use the robot, local restrictions may restrict the age of the operator.
- Do not allow children to be in vicinity or play with the robot when it is operating.
- Do not use the robot in areas where people are unaware of its presence.
- When manually operating the robot with the Mammotion app, do not run. Always walk, watch your steps on slopes, and maintain balance at all times.
- Avoid touching moving hazardous parts, such as the blade disk, until it has completely stopped.
- Avoid using the robot when there are people, especially children or animals, in the work area.
- If operating the robot in public areas, place warning signs around the work area with the following text:
"Warning! Automatic lawn mower! Keep away from the robot! Supervise children!"
- Wear sturdy footwear and long trousers when operating the robot.
- To prevent damage to the robot and accidents involving vehicles and individuals, do not set work areas or channels across public pathways.
- Seek medical aid in case of injury or accidents.
- Set the robot to **OFF** and remove the key before clearing blockages, performing maintenance, or examining the robot. If the robot vibrates abnormally, inspect it for damage before restarting. Do not use the robot if any parts are defective.
- Do not connect or touch a damaged cable until it is disconnected from the power outlet. If the cable

becomes damaged during operation, disconnect the plug from the power outlet. A worn or damaged cable increases the risk of electrical shock and should be replaced by service personnel.

- Only use the charging station included in the package to charge the robot. Incorrect use may result in electric shock, overheating, or corrosive liquid leakage from the battery. In case of electrolyte leakage, flush with water/neutralizing agent and seek medical aid if the corrosive liquid comes into contact with your eyes.
- Only use original batteries recommended by Mammotion. The safety of the robot cannot be guaranteed with non-original batteries. Do not use non-rechargeable batteries.
- Keep extension cords away from moving hazardous parts to avoid damage to the cords which can lead to contact with live parts.
- The illustrations/screens used in this document are for reference only. Please refer to the actual products.

1.2 Safety Instructions for Installation

- Avoid installing the charging station in areas where people may trip over it.
- Do not install the charging station in areas where there is a risk of standing water.
- Do not install the charging station, including any accessories, within 60 cm/24 in of any combustible material. Malfunctioning or overheating of the charging station and power supply can pose a fire hazard.
- For users in the USA/Canada: If installing the power supply outdoors, there is a risk of electric shock. Only install it in a covered Class A GFCI receptacle (RCD) with a weatherproof enclosure, ensuring that the attachment plug cap is inserted or removed.

1.3 Safety Instructions for Operation

- Keep your hands and feet away from the rotating blades. Do not place your hands or feet near or below the robot when it is turned on.
- Do not lift or move the robot when it is turned on.
- Stop the robot when there are people, especially children or animals, in the work area.
- Ensure that there are no objects such as stones, branches, tools, or toys on the lawn. Otherwise, the

blades may be damaged when they come into contact with an object.

- Do not put objects on top of the robot, charging station or RTK reference station.
- Do not use the robot if the **STOP** button is not functioning.
- Avoid collisions between the robot and people or animals. If a person or animal comes in the path of the robot, stop it immediately.
- Always set the robot to **OFF** when it is not in operation.
- Do not use the robot simultaneously with a pop-up sprinkler. Utilize the Schedule function to ensure that the robot and pop-up sprinkler do not operate at the same time.
- Avoid setting a channel where pop-up sprinklers are installed.
- Do not operate the robot in the presence of standing water in the work area, such as during heavy rain or water pooling.

1.4 Battery Safety

Lithium-ion batteries can explode or cause a fire if disassembled, short-circuited, exposed to water, fire, or high temperatures. Handle them with care, do not dismantle or open the battery, and avoid any form of electrical/mechanical abuse. Store them away from direct sunlight.

- Only use the battery charger and power supply provided by the Manufacturer. The use of an inappropriate charger and power supply can cause electric shocks and/or overheating.
- DO NOT ATTEMPT TO REPAIR OR MODIFY BATTERIES! Repair attempts may result in severe personal injury, due to explosion or electrical shock. If a leak develops, released electrolytes are corrosive and toxic.
- This appliance contains batteries that are only replaceable by skilled persons.

1.5 Residual Risks

To avoid injuries, wear protective gloves when replacing the blades.

2 Introduction

2.1 About Mammotion Luba

The Luba 2 AWD series, also referred as Luba, is a 4-wheel-drive robotic lawnmower with a suspension system that provides better grip through its spring. Luba is equipped with RTK GNSS navigation and virtual-mapping systems, which allow users to customize their mowing tasks by defining different mowing areas and schedules in the Mammotion app. Additionally, Luba offers an IoT service and a rain sensor, providing a hands-free and picture-perfect lawn maintenance experience.

The Luba 2 AWD is newly equipped with a 3D vision module, 4G module, Alexa voice control, anti-theft, etc., which are explained in the following sections.

The Luba 2 AWD series includes two types of models:

- Standard version (Model: 1000, 3000, 5000, and 10000) — provides cutting height of 25-70 mm/1-2.7 inches.
- H version (Model: 1000H, 3000H, 5000H, and 10000H) — provides cutting height of 55-100 mm/2.2-4 inches.

2.1.1 About 3D vision module

Luba is equipped with a 3D vision module that provides 3D vision positioning, 3D vision obstacle detection, and FPV mode.

- 3D vision positioning helps to guarantee positioning accuracy when RTK positioning fails due to poor satellite signals.
- Vision obstacle detection identifies obstacles in the front.
- FPV mode can be used for monitoring as a security camera.

2.1.2 About positioning

Luba is equipped with a RTK (real-time kinematic) navigation system, a multi-sensor integrated navigation system, and a 3D vision positioning system, which provide more accurate positioning data.

RTK positioning

RTK is a differential GNSS positioning technology that greatly enhances positioning accuracy to approximately 5 cm/2 in. Luba accesses four global navigation systems (GPS, GLONASS, BeiDou, and Galileo) and incorporates supplementary sensors, thus, providing nearly 100 times improved accuracy than conventional GPS systems.

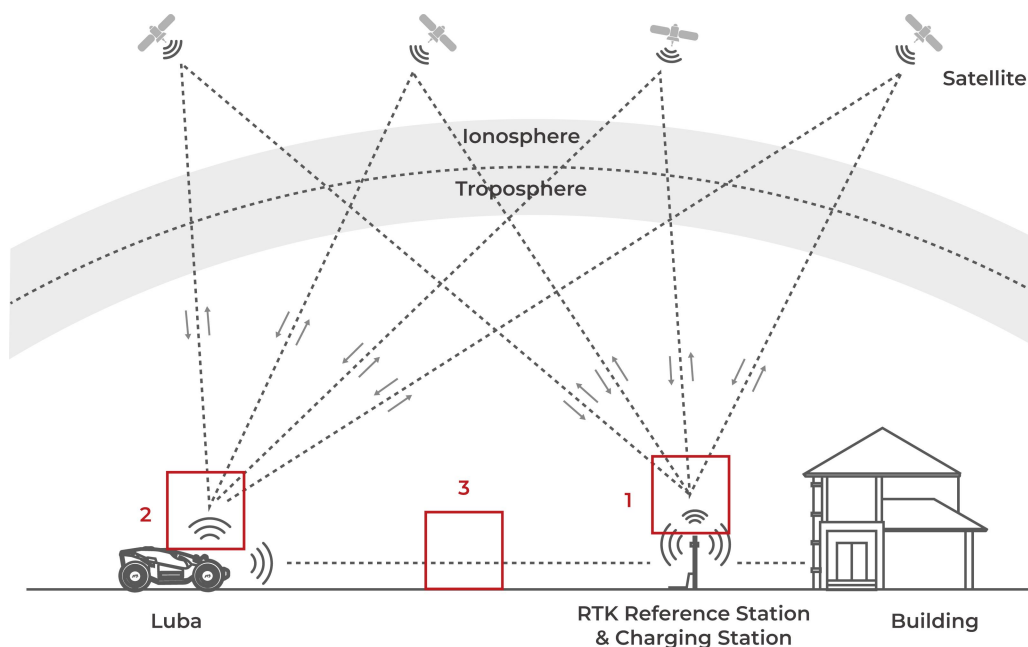

1. To perform its work, the RTK reference station receives satellite signals, requiring an obstruction-free environment and open-sky view.
2. Luba operates similarly, requiring an open sky view to receive satellite signals.
3. Data transmission from the RTK reference station to Luba is possible. This does not imply that there must constantly be an unobstructed view from every point on your lawn to the RTK reference station. As long as the transmission path is not completely blocked, the data can be transmitted via radio.

3D vision positioning

Luba primarily uses RTK positioning to locate itself. However, in situations where satellite signals are obstructed by obstacles such as eaves or trees during mapping and mowing, Luba can still operate effectively using the 3D vision positioning.

2.1.3 About obstacles detection

Luba supports both visual and ultrasonic obstacle detection. The 3D vision system can identify obstacles and respond accordingly, while the ultrasonic system is used to detect obstacles in low-light environments where visual identification is difficult.

2.1.4 About connectivity

Luba supports three methods of connectivity, namely, Bluetooth, Wi-Fi, and 4G cellular data. Bluetooth is used to connect Luba with your phone, while Wi-Fi and 4G cellular data are used to access the internet.

2.1.5 About lawn printing art

By utilizing AI algorithms to tailor the cutting path, cutting height, and angle, Luba can create special patterns via the Mammotion app. See [To add a pattern](#) for more information.

Luba is able to cut grass into various shapes and patterns and supports the following patterns now:

- 26 English letters and digits
- Soccer shape
- Heart shape
- Pentagram shape
- Four-point star shape
- Crescent shape
- Tree shape
- Basketball shape
- Rugby shape

2.1.6 About auto-recharge

Auto-recharge function allows Luba to automatically return to charge when the battery is lower than 15%.

2.1.7 About voice control

NOTE

Luba now supports voice commands in English, German, and French.

Luba is compatible with Alexa voice control. You can easily start or stop working or recharging by using simple voice commands. See [To link your Alexa account](#) to link your Alexa account.

Here are some voice command examples that allow you to start working, pausing, stopping, recharging, and checking the status:

Working

-Alexa, ask Mammotion robot to start working

-Alexa, ask Mammotion robot to start task xx (xx means the name of the task you set)

Pause working

-Alexa, ask Mammotion robot to pause

-Alexa, ask Mammotion robot to hold on

Continue working

-Alexa, ask Mammotion robot to continue

Stop working

-Alexa, ask Mammotion robot to stop working

Return to the charging station

-Alexa, ask Mammotion robot to recharge

-Alexa, ask Mammotion robot go home

Check status

-Alexa, ask Mammotion robot status

2.1.8 About anti-theft system

Luba has an anti-theft system to prevent unauthorized removal.

- The alarm is triggered when Luba is lifted.
- Users can track Luba's location by GPS and 4G positioning through the Mammotion app, as long as it is online.
- Additionally, Luba's structure allows for an AirTag to be attached to track its location.

2.2 In the Box

Ensure the parts can be found in the package according to your option. If any parts are missing or damaged, contact your local dealer or our after-sales support.

2.2.1 Luba installation kit

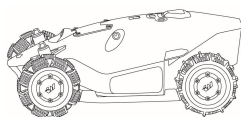

Luba x1

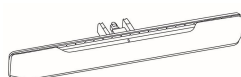

Luba Bumper x1



Screw x4 (2 pcs for spare use)



Key x2



Vision Module x1

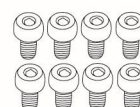

Screw x8 (4 pcs for spare use)

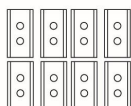

Replacement Blades x8 (for spare use)



Washer x8 (for spare use)



Screw x8 (for spare use)

2.2.2 Charging station installation kit

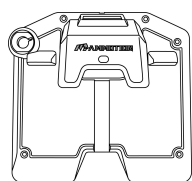

Charging Station x1

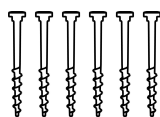

Stake x6



Gasket x2

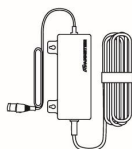

Charging Station Power Supply x1



Charging Station Extension Cable (10M) x1

2.2.3 RTK installation kit



RTK Reference Station x1



Radio Antenna x1



Trident Ground Stake x1

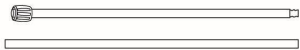

Mounting Pole x2

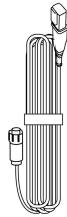

RTK Reference Station Extension Cable (10M) x1

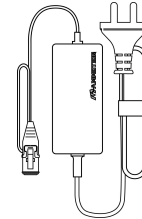

RTK Reference Station Power Supply x1

2.2.4 Tool kit



Allen Key 8mm x1



Allen Key x1

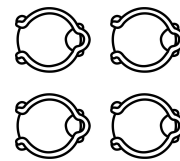

Cord Tie x4

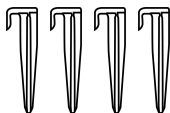

Cable Peg x4



SIM-eject Tool x1

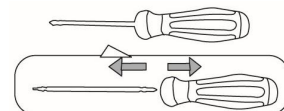

Screwdriver (Phillips bit+2.5mm hex bit) x1

2.2.5 Other accessories (optional)

The following accessories are sold separately.

RTK reference station wall mount kit

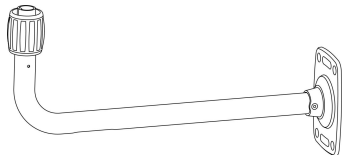

RTK Wall Mount x1



M8x50 Expansion Bolt x4

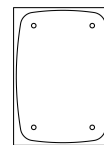

Drilling Template x1

Luba garage



Luba Garage x1

RTK solar panel kit

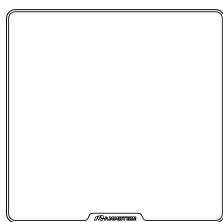

Solar Panel x1

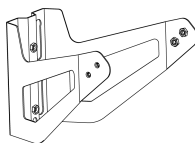

Mounting Bracket x1

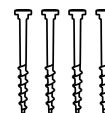

Stake x4

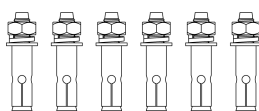

**Expansion Bolt x6
(2pcs for spare use)**



**Screw x6
(2pcs for spare use)**

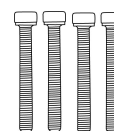

**M5x40 Screw x4
(2pcs for spare use)**



Allen Key 1.5mm x1





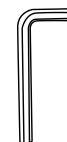









Allen Key 4mm x1











Allen Key 8mm x1

2.3 Symbols on the Product

These symbols can be found on the product. Study them carefully.

| Symbol | Description |
|---|---|
|  | Warning. |
|  | Read user manual before operating the product. |
|  | This product complies with the applicable EU Directives. |
|  | This product complies with the applicable UK Directives. |
| Made in China | This product is manufactured in China. |
|  | It is not permitted to dispose this product as normal household waste. Ensure that the product is recycled in accordance with local legal requirements. |
|  | This item can be recycled. |
|  | Keep the pack of this product dry. |
|  | The pack of this product should not be covered. |
|  | Prohibit flipping. |
|  | This product is fragile. |
|  | The pack of this product/the product should not be tread. |
|  | Class III appliance. |

| Symbol | Description |
|---|--|
|  | Keep hands or feet away from movable blades. |
|  | Do not ride on the product. |
|  | Keep a safe distance from your product when operating. |
|  | WARNING: Do not touch rotating blade. |
|  | WARNING: Read the user instructions before operating the product. |
|  | WARNING: Danger of projections of objects against the body. Keep an adequate safe distance from the machine while it is running. |
|  | WARNING: Do not put hands and feet near or under the opening of the cutting means. Remove the disabling device before operating on the machine or before lifting it. |
|  | WARNING: Do not ride on the product. Never put your hands or feet close to or under the product. |

2.4 Product Overview

2.4.1 Luba

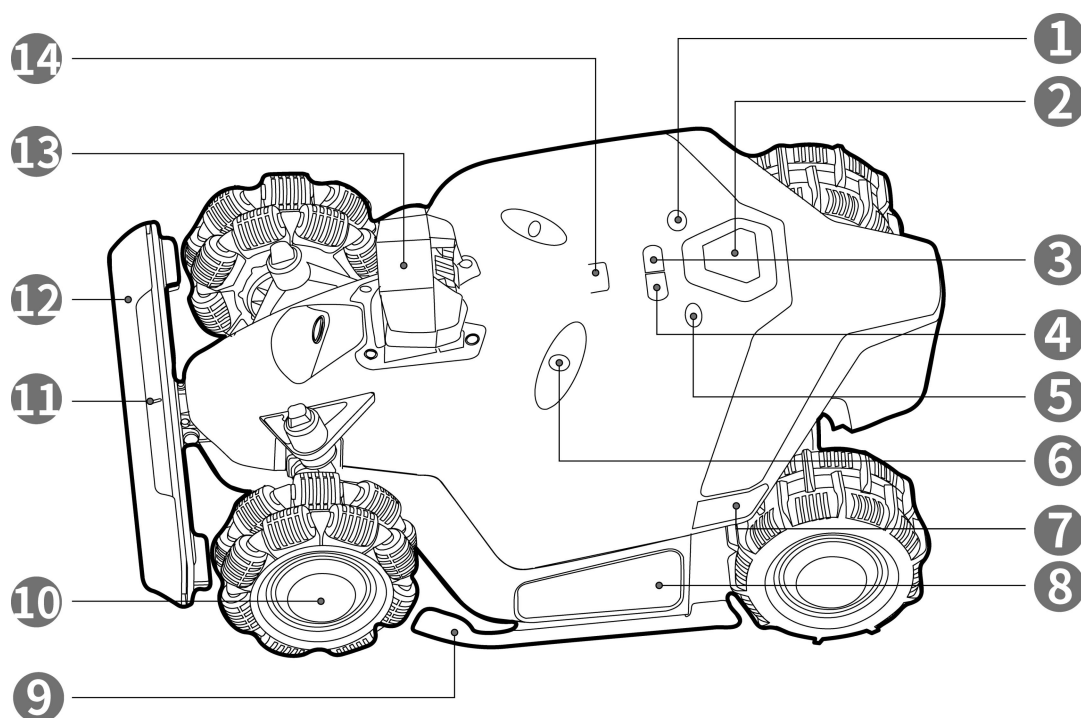

Figure 2- 1 Front View of Luba

- | | |
|--|---|
| 1. Start Button | 2. Emergency Stop Button |
| 3. Auto-return Button — press to call back Luba ¹ | 4. Grass Button — press to continue the task ² |
| 5. Power Button — long press to turn on/off Luba | 6. Ultrasonic Sensor |
| 7. Side Indicator | 8. Cushion |
| 9. Protection Bracket | 10. Omni Wheel |
| 11. Front Indicator | 12. Bumper |
| 13. Vision Module | 14. Rain Sensor |

NOTE

1. To come back to charging station: press **Auto-return** 🏠, then press **START**.
2. To continue task: press **Grass** 🌿, then press **START**.

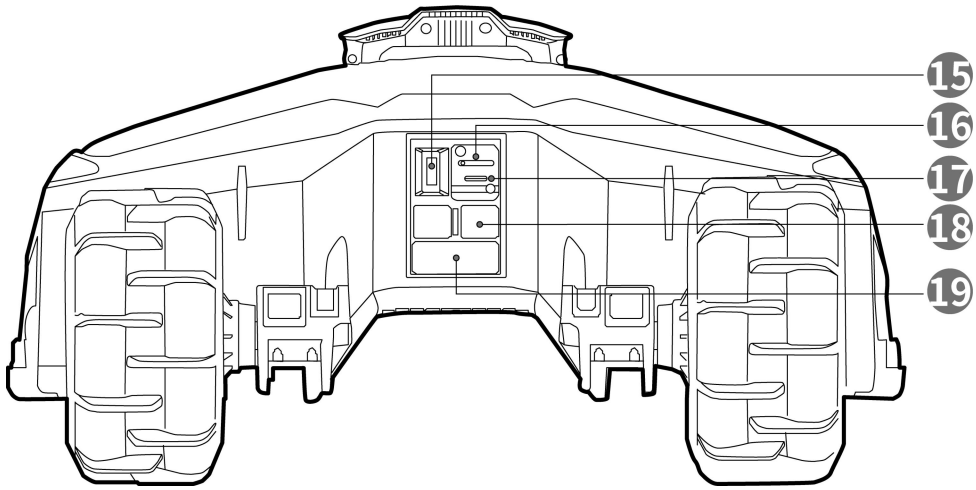

Figure 2- 2 Rear View of Luba

- 15. Key Slot
- 16. SIM Card Tray
- 17. USB Port — for troubleshooting and debugging
- 18. Charging Pad
- 19. Infrared Receiver

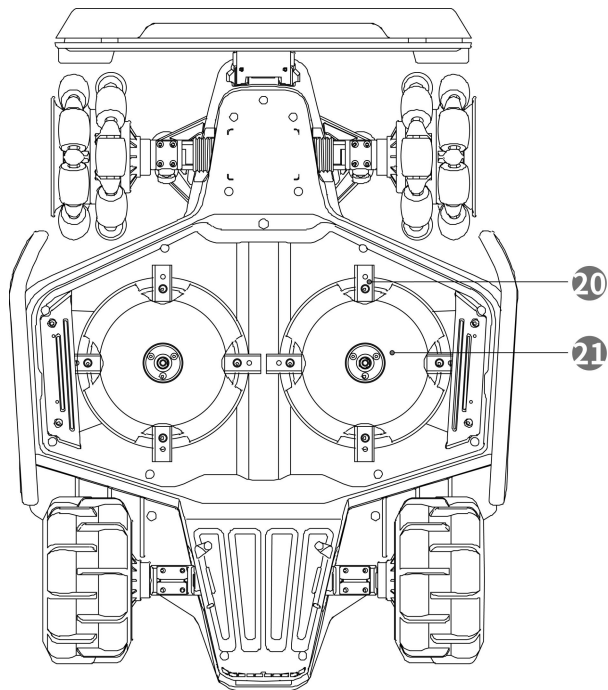

Figure 2- 3 Bottom View of Luba

- 20. Cutting Blade
- 21. Cutting Disk

2.4.2 RTK solar panel

1. LED
2. Power
3. Vent

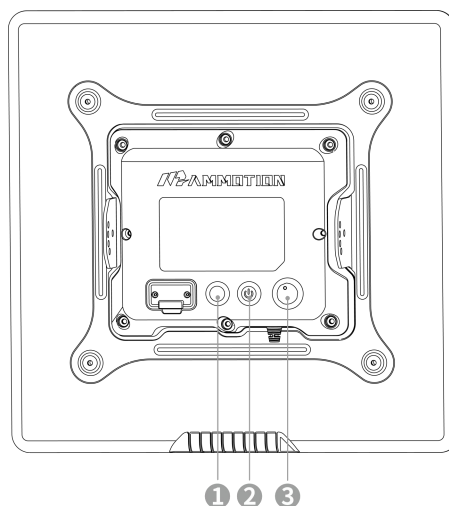

Figure 2- 4 Rear View of Solar Panel

- The solar panel unit will activate automatically when placed outdoors.
- The power button can only be available indoors or in the absence of sunlight. To turn on/off the unit, press the power button until the LED light turns on/off.
- To reset the unit, hold down the power button for 5 seconds.
- The unit will adjust its operation based on the battery level in the following manner:

| Battery Level | Status |
|--|-------------------------|
| > 10 V | Operates normally |
| 9.5-10 V | Dormant |
| < 9.5 V | Power off automatically |
| Battery level < 9.5V; PV charging power > 3 W | Operates normally |

3 Installation

3.1 Preparation

- Read and understand the safety instructions prior to installation.
- Use original parts and installation materials.
- Sketch your lawn and mark up obstacles. This will make it easier to examine where to place the charging station and RTK reference station, and to set the virtual boundaries.

3.2 Choosing a Location for RTK Reference Station

To optimize the performance of the RTK system, the RTK reference station must be in an open area to receive satellite signals. You can install the RTK reference station on flat, open ground or on an unobstructed wall or roof. In general, if your lawn is L-shaped, you can place the RTK reference station on a wall or roof or on the ground; if your lawn is O-shaped or U-shaped, or if you have multiple lawns, we recommend that you place the RTK reference station on a wall or roof.

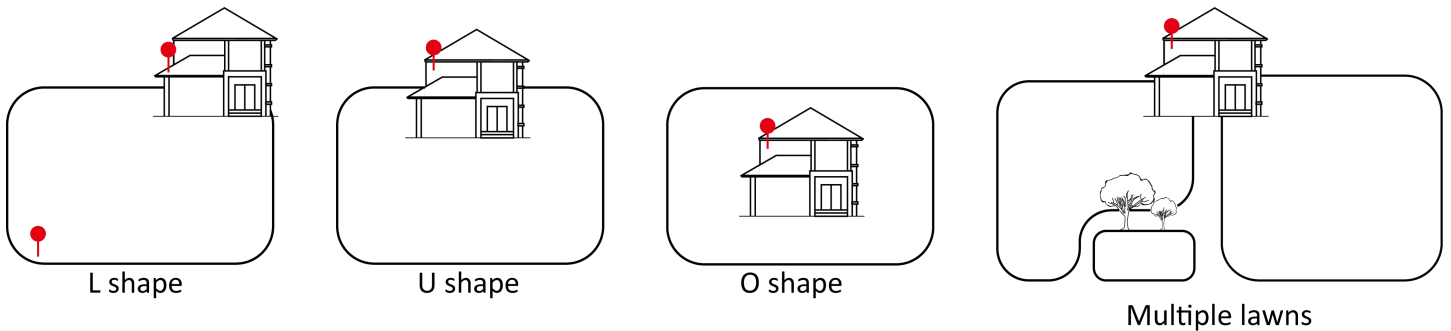

The location requirements are as follows:

- The RTK reference station should be oriented vertically, as shown below:



- Place the RTK reference station on a flat, open ground or on an unobstructed wall or roof. Make sure there are no roofs or trees that may obstruct the satellite signals.
- DO NOT install the RTK reference station at the corner of an L-shaped building or on a narrow path between two structures or under a tree.

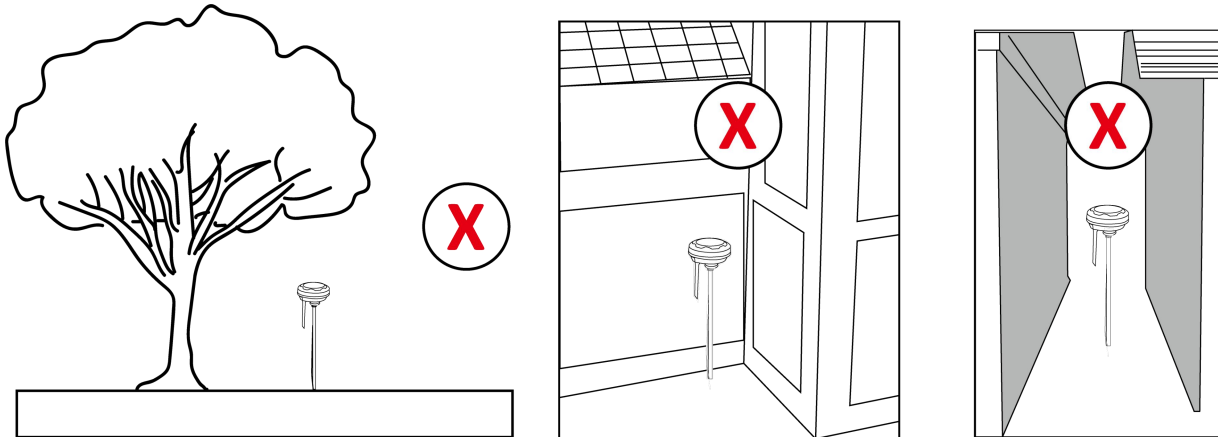

If you need to install an RTK solar panel kit, for optimal exposure to sunlight, Mammoth recommends the following locating guidelines:

- If your home is located north of the equator, place the solar panel unit facing south;
- If your home is located south of the equator, place the solar panel unit facing north;

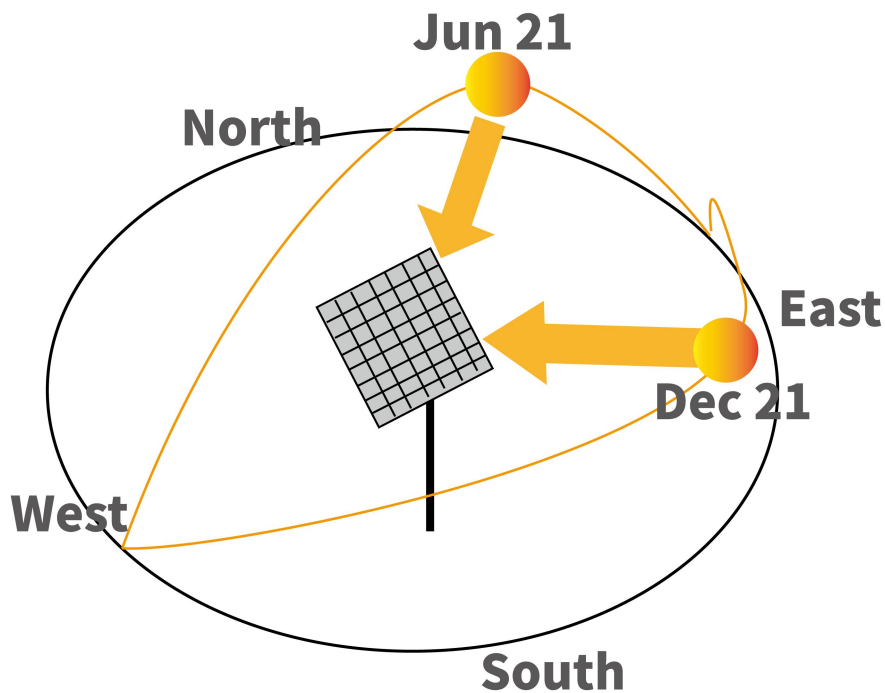

- The ideal angle for the solar panel kit is parallel to your location's latitude.
- In winter, it is generally recommended to add 15 degrees more than your location's latitude to maximize its efficiency.

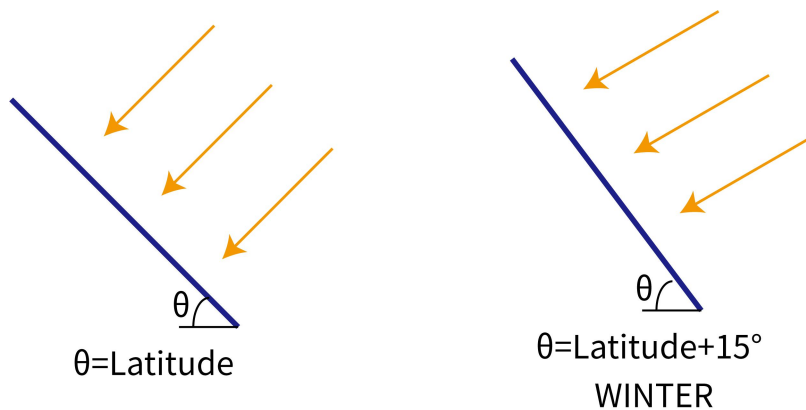

3.3 Choosing a Location for Charging Station

- Place the charging station on a flat ground.
- DO NOT install the charging station at the corner of an L-shaped building or on a narrow path between two structures.
- The charging area (1x1.5 m/3x5 ft. in front of the charging station) should be free of obstacles or other items.
- The base plate of the charging station must not be bent or tilted.

Here are some examples to clearly show correct and wrong settings:

- Flat and solid ground
- Short grass



- On a slope

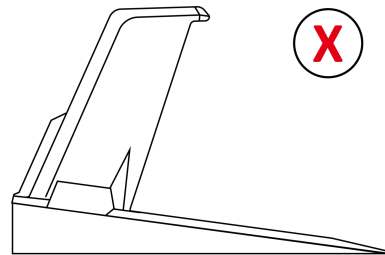

- Ground not flat
- Easy to bend when a heavy object on it, such as Luba.

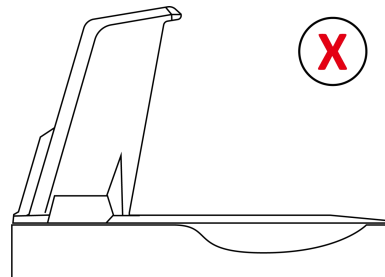

- Thick grass
- Easy to bend when a heavy object on it, such as Luba.

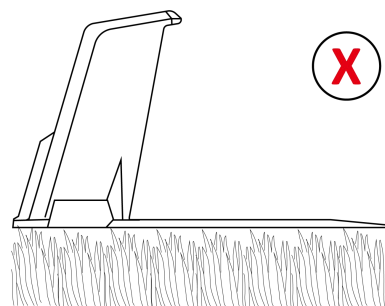

3.4 Installing

3.4.1 RTK reference station installed on a wall/roof (recommended)

1. Choose a suitable installation area at a high place of your house.
2. Stick the drilling template on the wall and drill four holes (10 x 40mm/0.4 x 1.6 in) at the appropriate position.
3. Attach the RTK wall mount on the wall using the four bolts (M8 x 50) and secure the bolts firmly.
4. Fix the radio antenna to the RTK reference station.
5. Route the RTK reference station cable into the wall mount as shown.
6. Attach the RTK reference station to the wall mount.
7. Connect the RTK reference station plug to the RTK reference station extension cable (10 m/33 ft.).

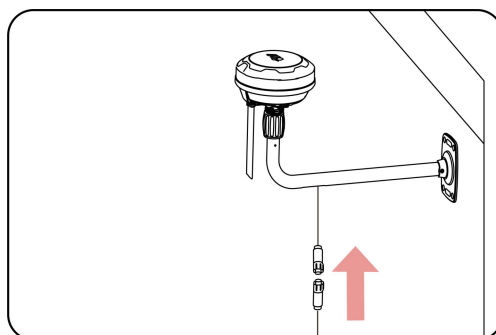
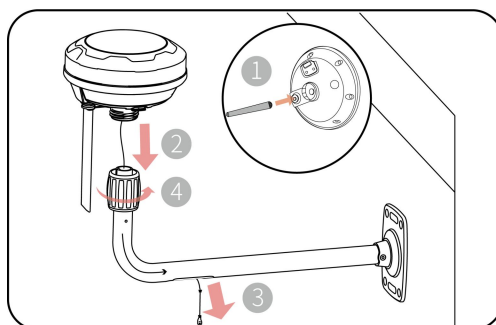
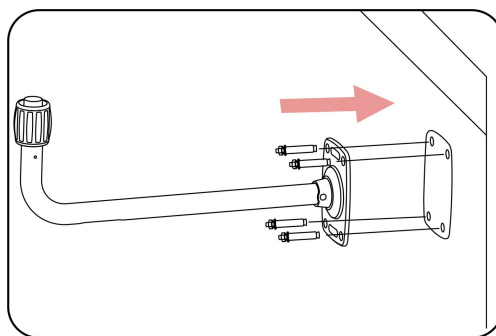
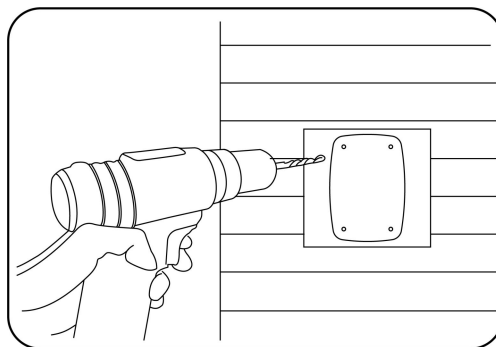

8. Connect the RTK reference station cable (10 m/33 ft.) to the RTK reference station power supply.

9. Plug the power supply into a wall socket.

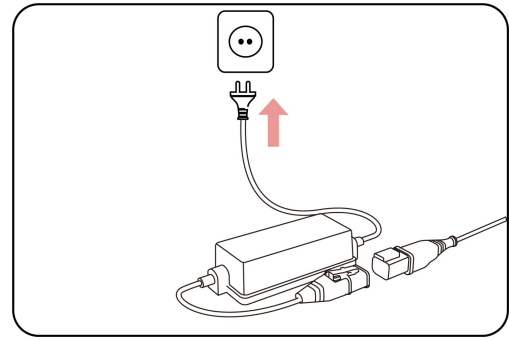

10. Select an open spot to install the charging station.

11. Use the six stakes to properly fasten the charging station in the position as shown.

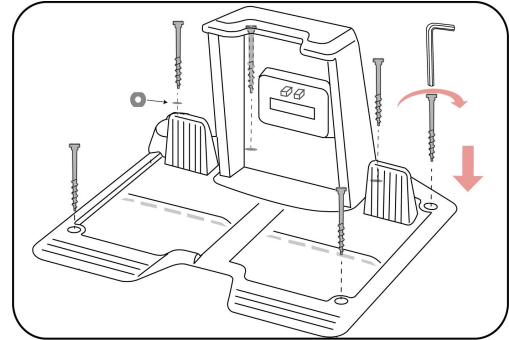

12. Connect the wires as shown in the figure.

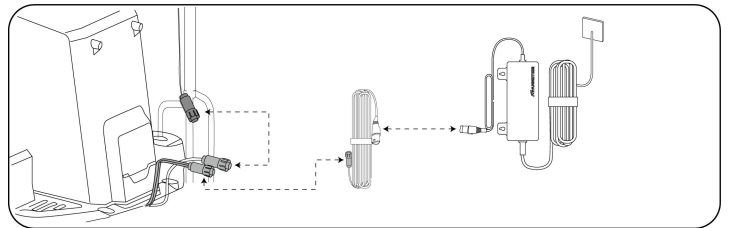

3.4.2 RTK reference station installed on the ground

1. Fix the radio antenna to the RTK reference station.

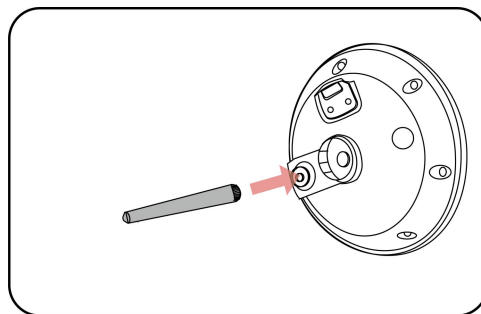

2. Assemble the two mounting poles and the trident ground stake as shown.

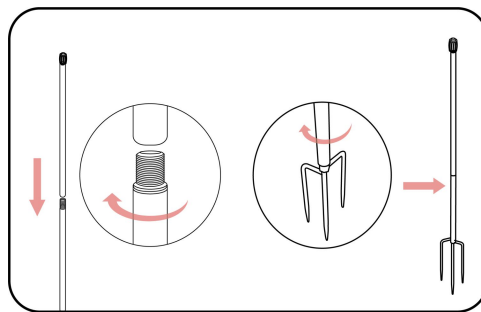

3. Route the RTK reference station cable into the mounting pole as shown.

4. Mount the RTK reference station on the mounting pole.

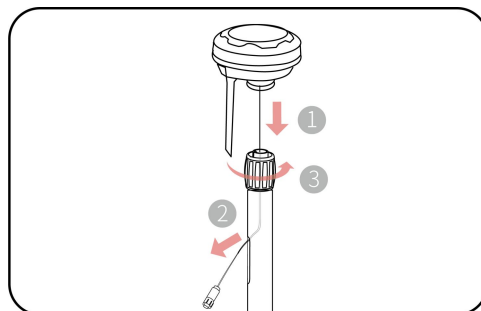

5. Secure the charging station on the flat surface using the five stakes. Place a gasket onto the inlet, then insert and fix the trident ground stake as shown in the figure and keep it upright.

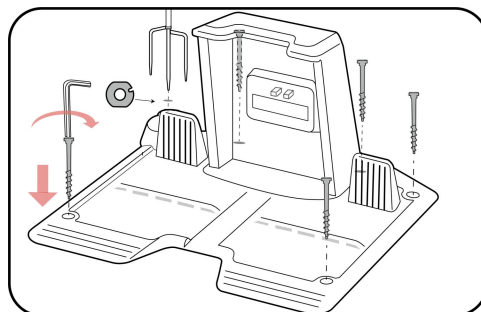

6. Connect the wires as shown in the figure.

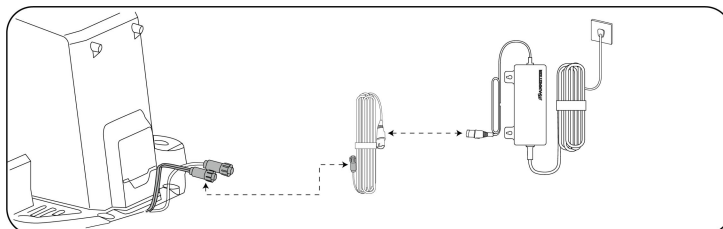

3.4.3 Luba Assembly

Installing the vision module

1. Loosen the four screws using a screwdriver with a 2.5mm hex bit to remove the cover.

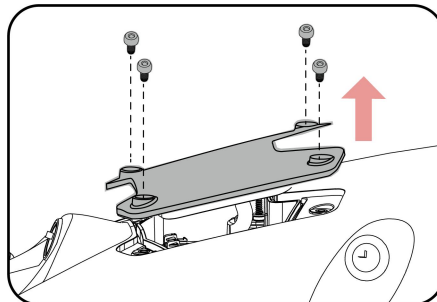

2. Connect the vision module wires (black to black and white to white).

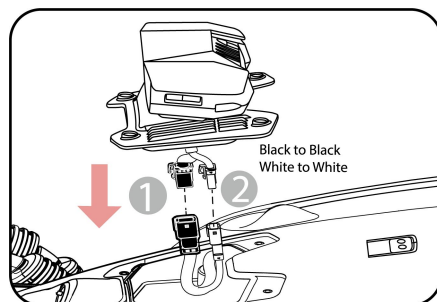

3. Attach the vision module to the Luba using the four screws and tighten them with a 2.5mm hex screwdriver.

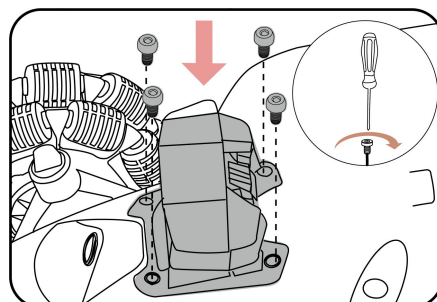

Installing the Luba bumper

1. Gently pull the plug inside the Luba out and connect it to the bumper.

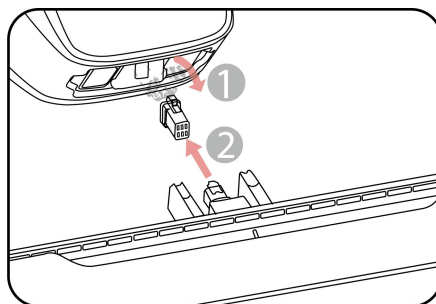

2. Place the bumper into position with the front indicator facing upwards by pressing and holding the buttons.

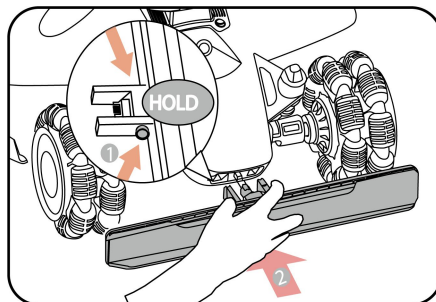

3. Install and tighten the two screws using a 2.5mm hex screwdriver.

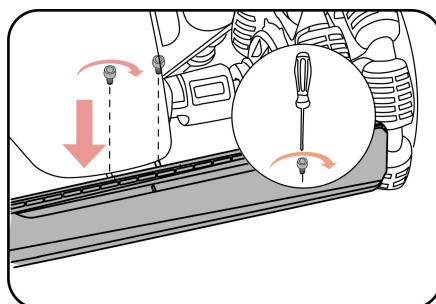

Installing the security key

Insert a key into the rear key slot.

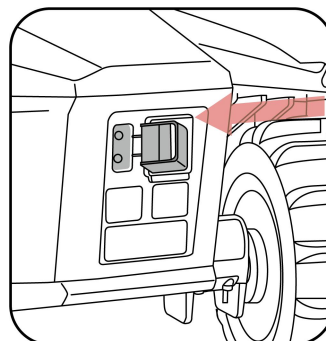

Installing the 4G sim card (optional)

IMPORTANT

Activate the SIM card on your phone before installation.

1. Use the Allen key to detach the rear cover.

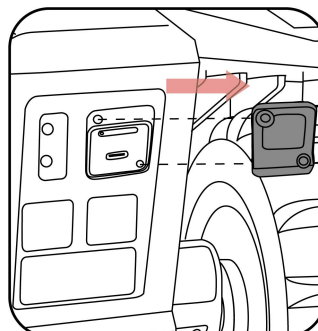

2. Eject the SIM card tray using the SIM-eject tool, install the SIM card, and push the card tray into place.

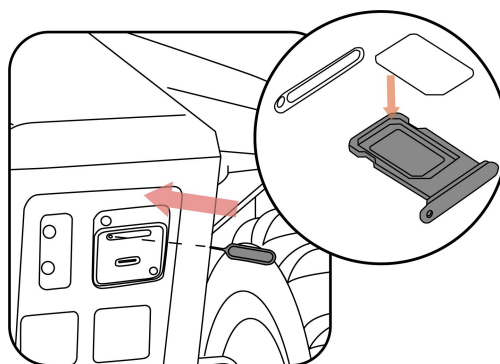

3. Reinstall the rear cover.

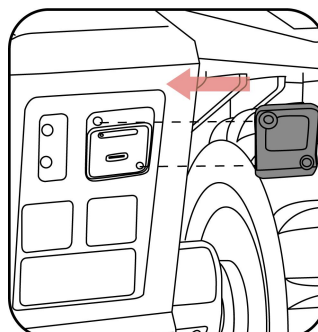

3.4.4 Installing the RTK solar panel kit (optional)

NOTE

There are three options to install the RTK solar panel kit. Please decide the optimal one to continue.

Before installing, expand the bracket outward to properly accommodate the solar panel.

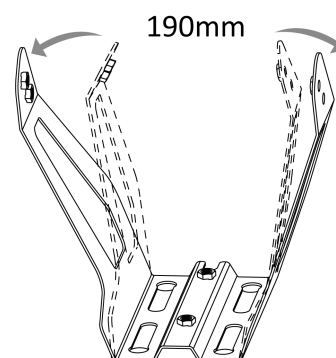

Option 1: Install the RTK solar panel kit on a wall

1. Place the mounting bracket on the wall and mark four holes with a pencil, ensuring the distance is within the cable's reach.

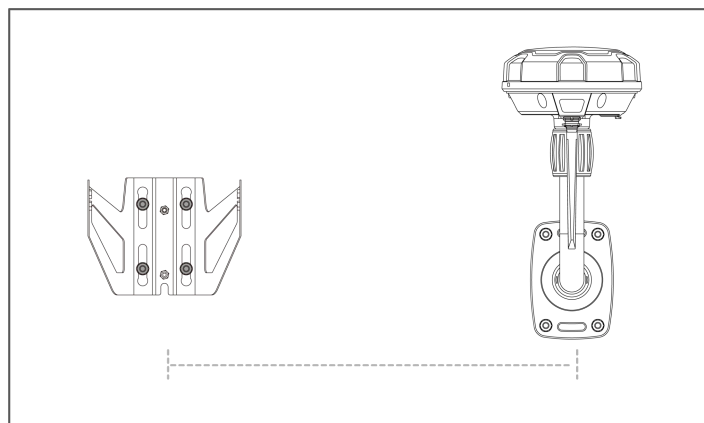

2. Drill 10mm/0.4 in. diameter, 35mm/1.4 in. depth holes.

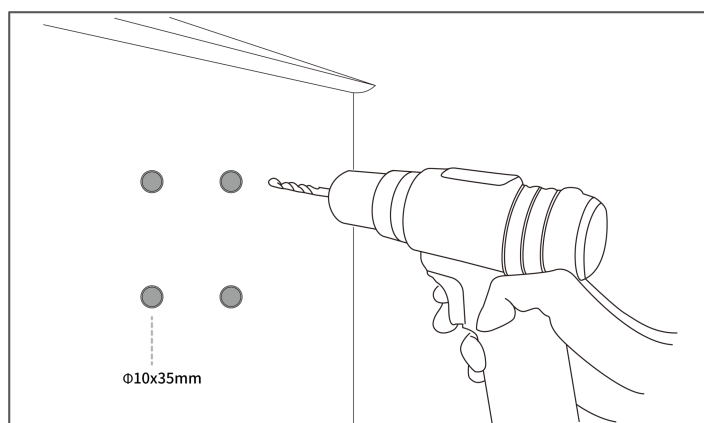

3. Tap the expansion bolts into the holes and remove the nuts, spring and flat washers when the expansion bolts are stuck.

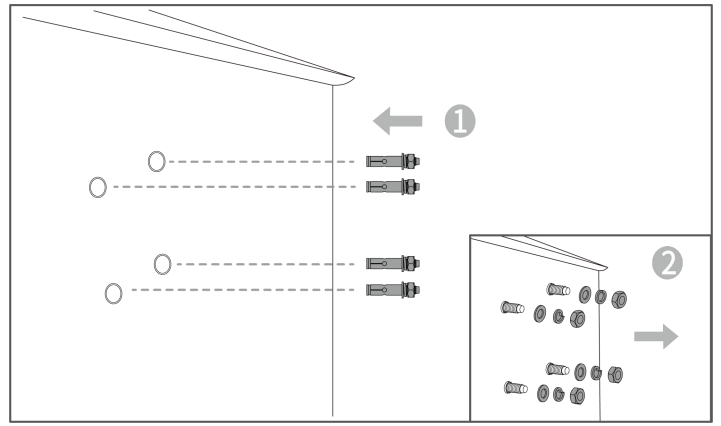

4. Attach the bracket to the wall without reversing it. Reinsert washers, spring washers, nuts, and tighten with a 13mm/0.5 in. socket wrench.

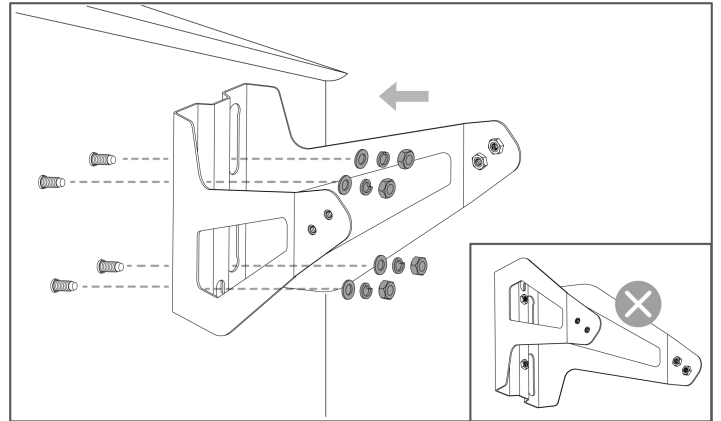

5. Secure the solar panel to the bracket with four screws and tighten using a 4mm/1.5 in. Allen key.

6. Adjust the angle by shifting the screw to another hole if needed.

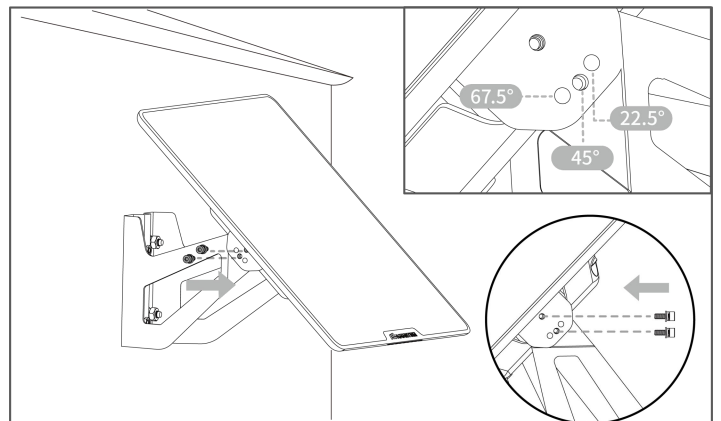

7. Connect the solar panel cable to the RTK reference station cable.

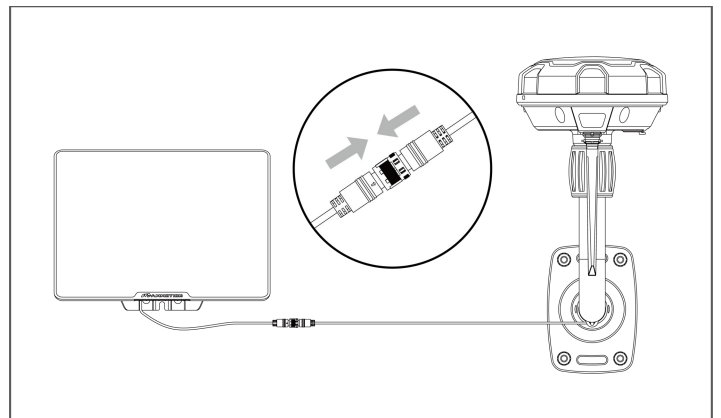

Option 2: Install the RTK solar panel kit on a flat ground/roof

1. Reverse and place the mounting bracket on the surface, secure with stakes or expansion bolts, ensuring the distance is within the cable's reach.

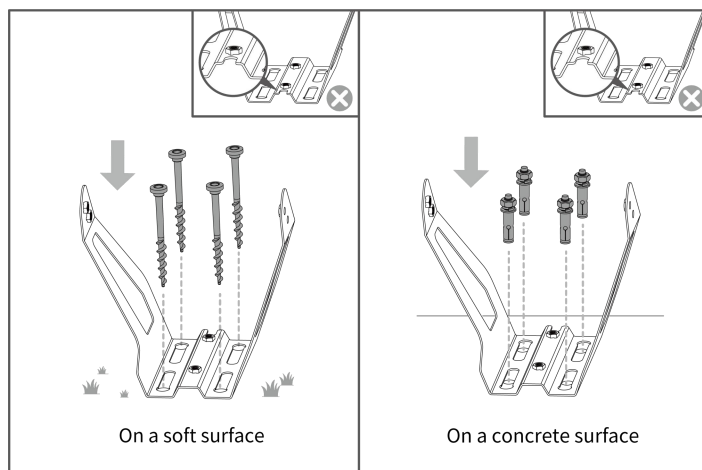

2. Secure the solar panel to the bracket with four screws and tighten using a 4mm/1.5 in. Allen key.
3. Adjust the angle by shifting the screw to another hole if needed.

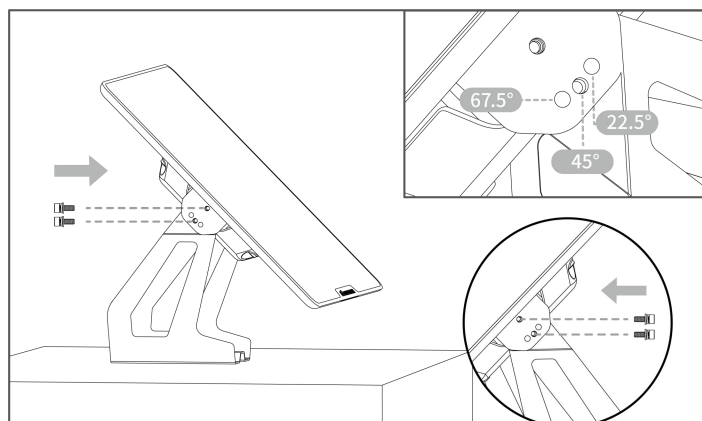

4. Connect the solar panel cable to the RTK reference station cable.

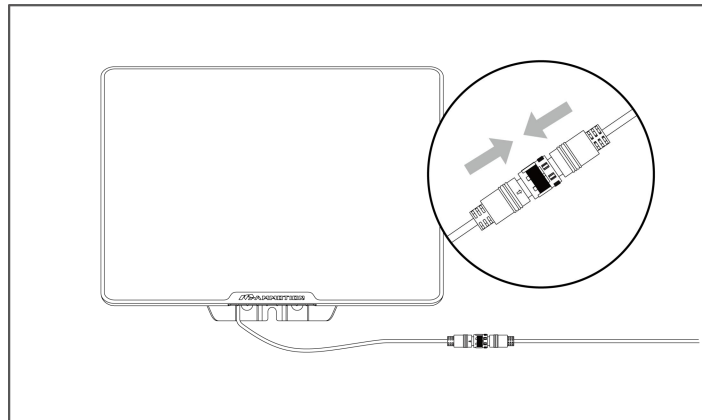

Option 3: Install the RTK solar panel kit on a RTK wall mount (sold separately)

1. Mount the bracket onto the RTK wall mount with two screws (M5x40). Tighten the screws using a 4mm/1.5 in. Allen key. Avoid reversing the mounting bracket during installation.

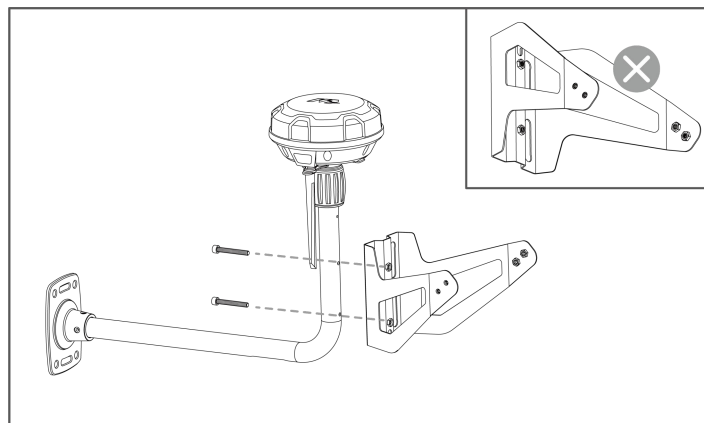

2. Secure the solar panel to the bracket with four screws and tighten using a 4mm/1.5 in. Allen key.
3. Adjust the angle by shifting the screw to another hole if needed.

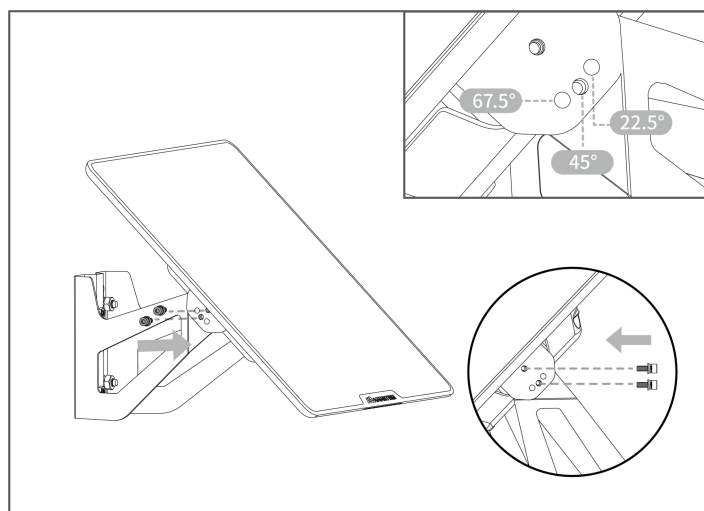

4. Connect the solar panel cable to the RTK reference station cable.

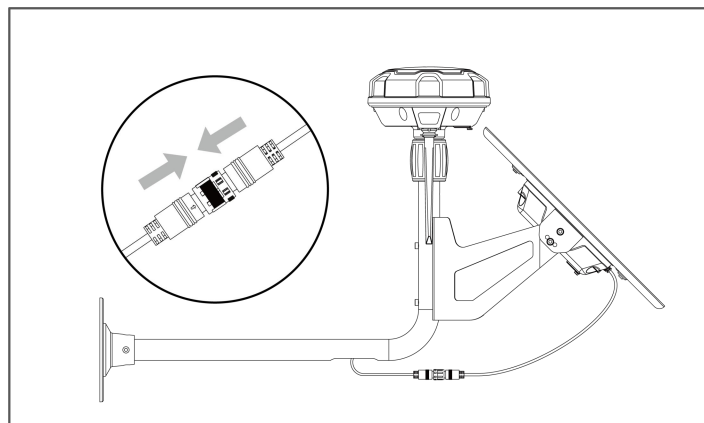

3.4.5 Installing the Luba garage (optional)

Attach the garage to the top of the charging station from front to back and tighten the two screws on the back of the garage to complete the installation.

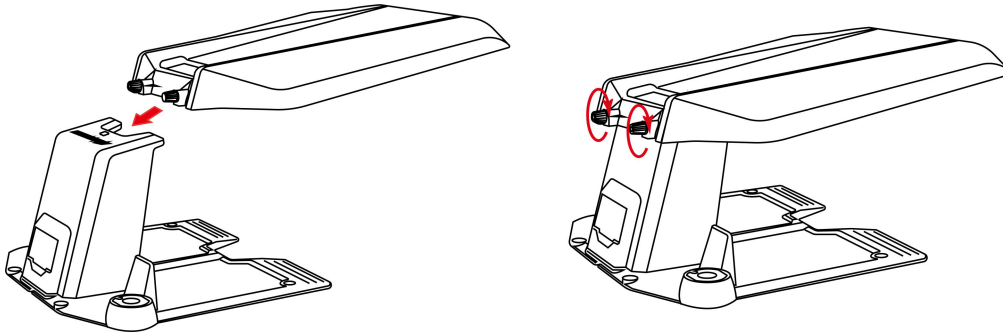

If it snows a lot in your area during the winter, it is recommended to store Luba indoors. If Luba is stored under the garage, clear the snow before starting work. Remove any ice from the shaft before lifting the garage.

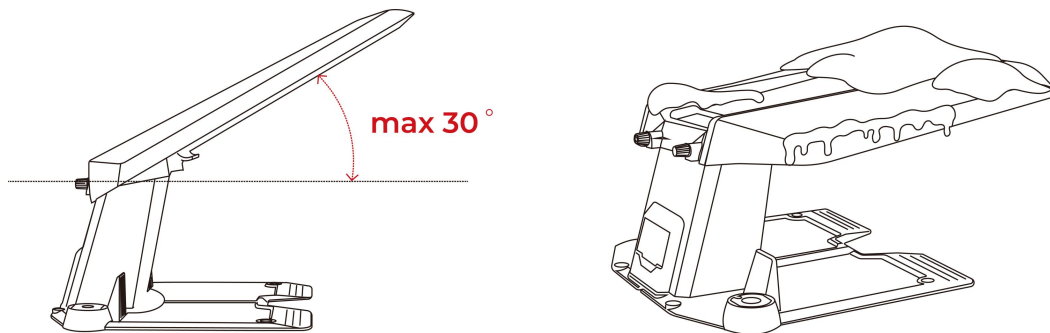

NOTE

- Do not place anything on top of the garage to avoid damage and interference with the Luba signal.
- The garage can be lifted to a maximum angle of 30°.

3.4.6 Activating Luba

Luba comes factory-set in 'transportation mode'. After the charging station and RTK reference station have been properly installed, please charge Luba before use.

1. Connect the charger of charging station to the power supply; the LED should display a constant green light.
2. Place Luba on the charging station, ensuring the charging pad on the rear is connected to the pin of the charging station, and the side LED lights up.
3. Continue charging Luba until the LED on the charging station flashes green and the side LED on Luba flashes red.

Once these steps are completed, Luba will be activated and ready for use.

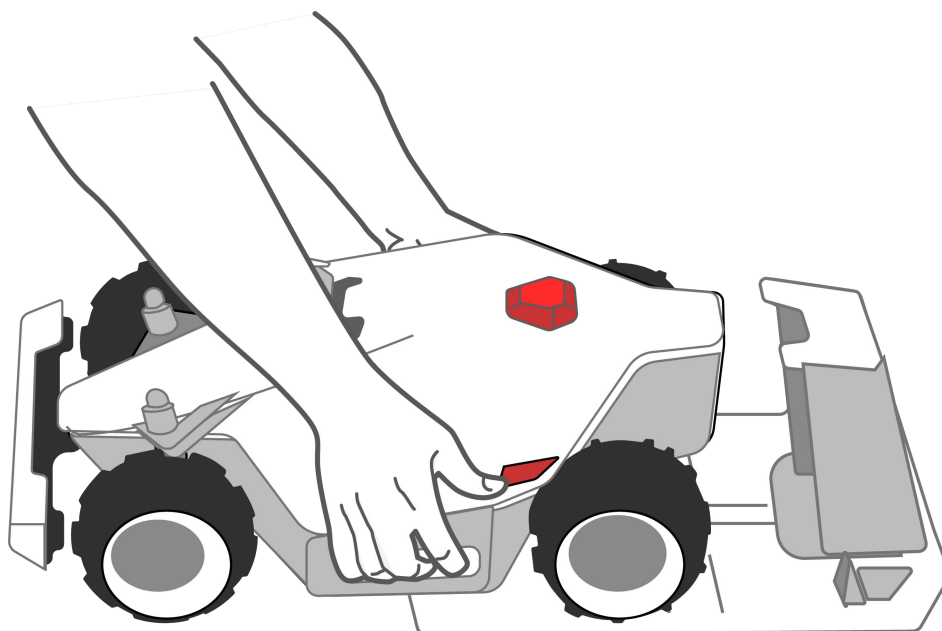

4 Operation

NOTE

The screens are only for reference. Please refer to the actual ones.

4.1 Preparation

- Read and understand safety instructions before operation.
- The charging station and RTK reference station have been properly installed.
- Ensure Luba has already docked on the charging station.
- Ensure there is a good Wi-Fi or hot spot signal.
- Keep your phone Bluetooth on.

4.2 Download Mammotion App

Luba is designed to work with the Mammotion app, please download the free Mammotion app first. You can scan the QR code below to get it from the Android or Apple app stores, or search for Mammotion in these stores.

Get it on Google Play store



Available on the Apple App Store



4.3 Mammotion Account Sign-up and Login

4.3.1 To sign up

NOTE

If you already have a Mammotion account, input your account and password to log it in.

After successfully install the Mammotion app in your phone, you are ready to create your account. Follow the below instructions to register one.

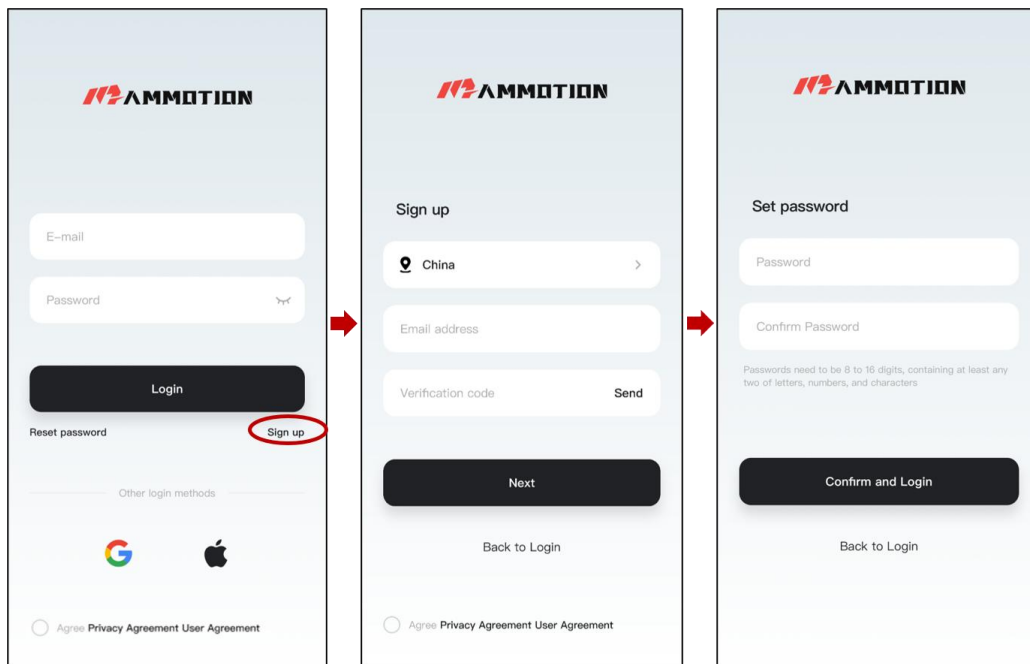

1. Tap **Sign up**.
2. Select your country, input your email address.
3. Tap **Send**. A verification code will be sent to your email (If you do not receive the code, please check your spam folder or the blacklist of your email).
4. Input the code (The verification code is valid for 10 minutes. If it expires, tap **Send** again to get a new one).
5. Check the Privacy Agreement User Agreement and click **Next** to set your password (Passwords must be 8 to 16 characters with at least two of the following: letters, numbers, and special characters.).
6. Tap **Confirm and Login** to finish the sign-up.

4.3.2 To log in

Log in with a Mammotion account

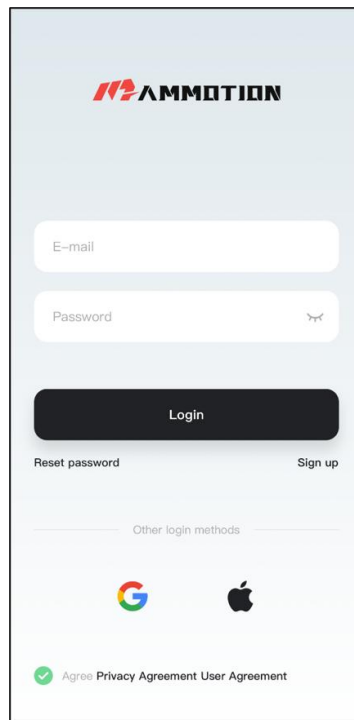

NOTE

If you forget your password, click **Reset password** and follow the screen instructions to reset your password.



Input your email address and password, check **Privacy Agreement User Agreement**, then tap **Login**.

Log in with a third-party account

1. Tap  or  (available for iOS user only) on the login page and you will be redirected to access the third-party authorization permission.

2. Select **Associated account** to link your Mammotion account if you already have a Mammotion account.

Or,

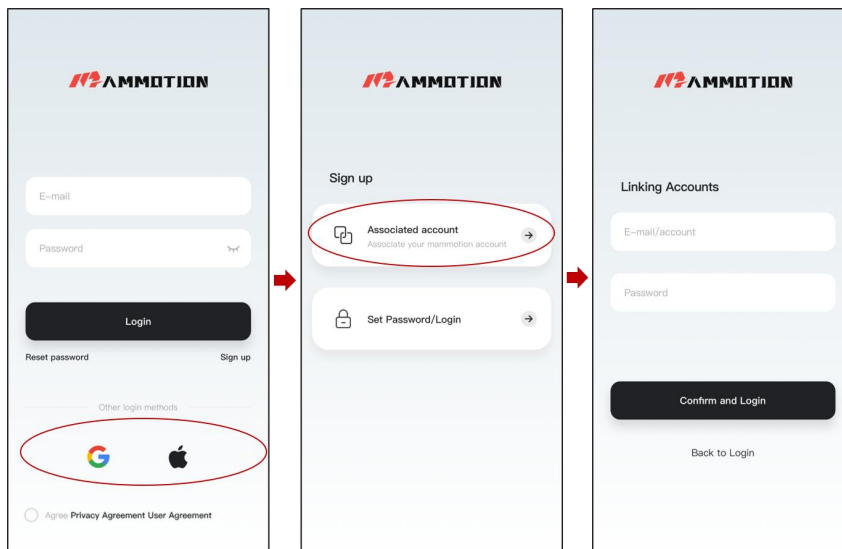

3. Tap **Set Password/Login** to set your password for the Mammotion account you are logging in.

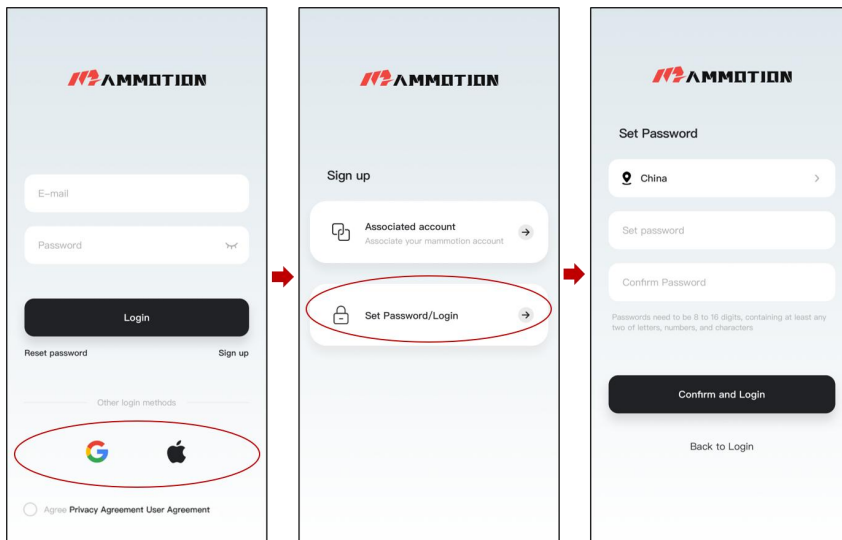

4. Tap **Confirm and login** to log in.

4.4 Add Your Robot

NOTE

- Make sure the distance between your phone and the robot is less than 3 m/10 ft.
- You can skip the Wi-Fi setup if you are using 4G cellular data. It is advisable to also establish a connection to a Wi-Fi network for optimal performance.

4.4.1 Add Luba

1. Click + to add your Luba.
2. Select **Add Luba 2**.
3. Follow the onscreen guidelines to set up Luba.
4. Long press (5 s) the power button to turn on Luba.
5. Follow the onscreen instructions to connect Luba via Bluetooth and set network successfully.

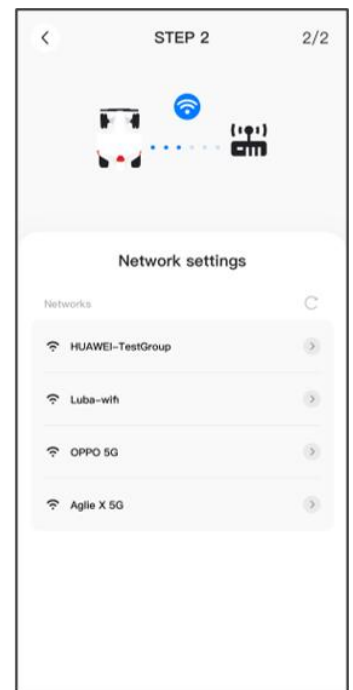
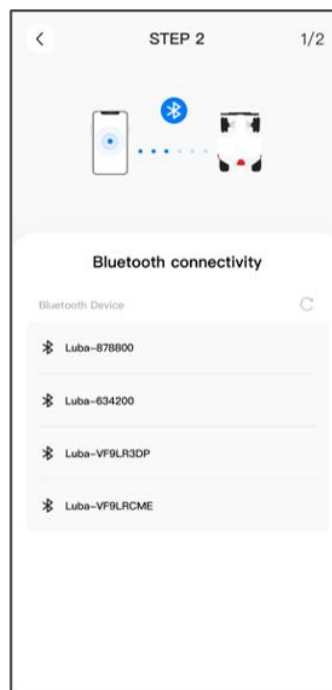
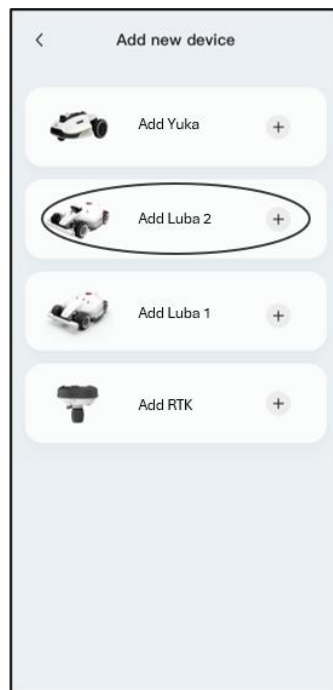

4.4.2 Add RTK reference station

The RTK reference station can also be added to check its data such as the number of satellites received, signals, etc. Click **Add RTK** to continue if needed.

1. Supply power to the RTK reference station and it will turn on automatically.
2. Switch to the last page to add device.
3. Select **Add RTK**.
4. Follow the onscreen instructions to connect RTK reference station via Bluetooth and set network successfully.
5. Go to **Settings > Device information** on the RTK reference station page to check its data if necessary.

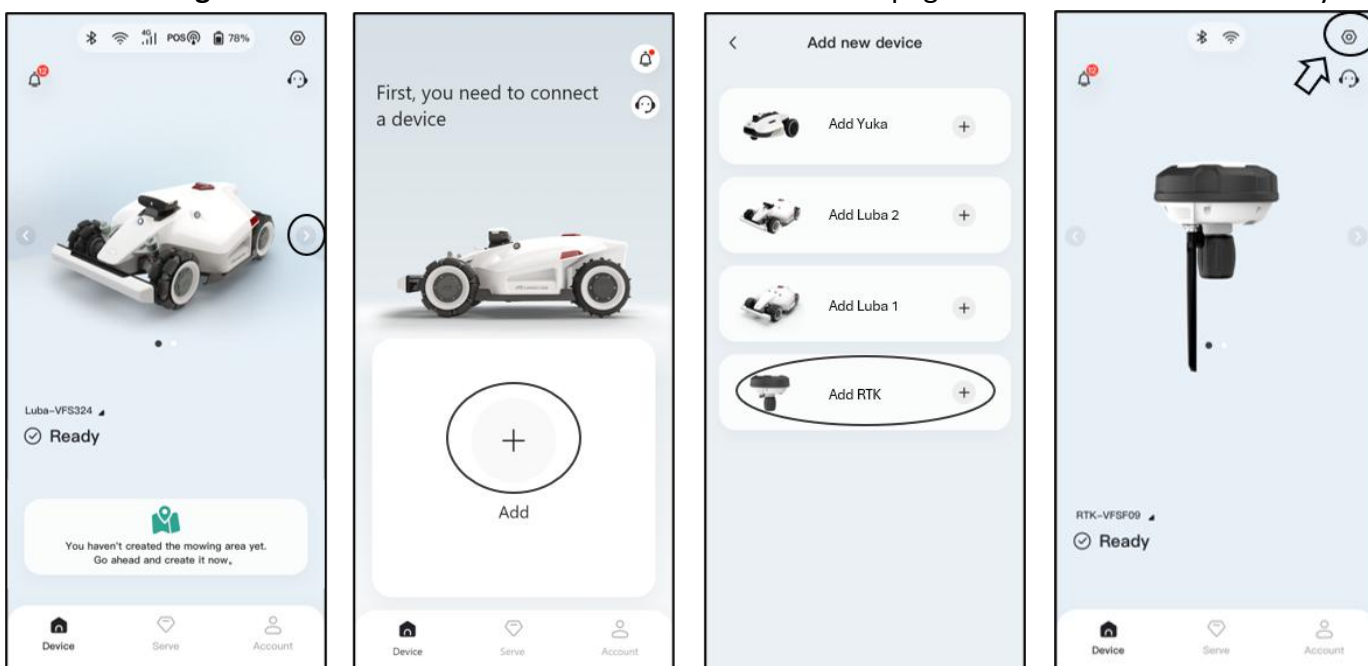

4.5 Main Page Introduction

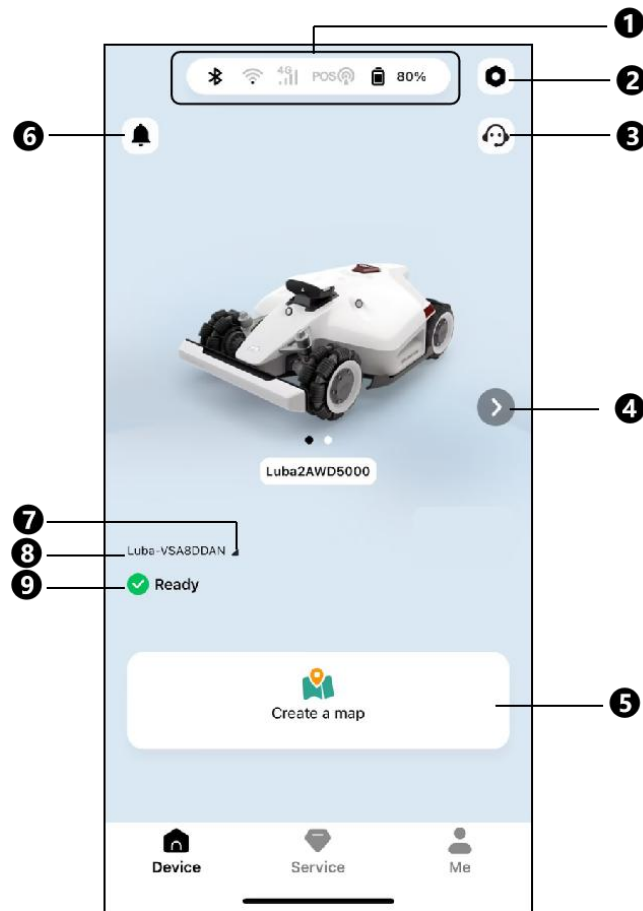

1. Status bar¹
2. Settings²
3. Customer service³
4. Switch device
5. Create
6. Notification⁴
7. Drop-down button⁵
8. Device serial number
9. Device status⁶

NOTE

1. See [Status bar](#) for further information.
2. See [Settings](#) for further information.
3. See [Customer service](#) for further information.
4. See [Notification](#) for further information.
5. Tap to open the Rename and Device information menu.
6. The Device status will vary according to the actual conditions.

After a task area is created, you can start working or set a task schedule.

- Tap ▶ to quickly start mowing.
- Tap + to set a task schedule.

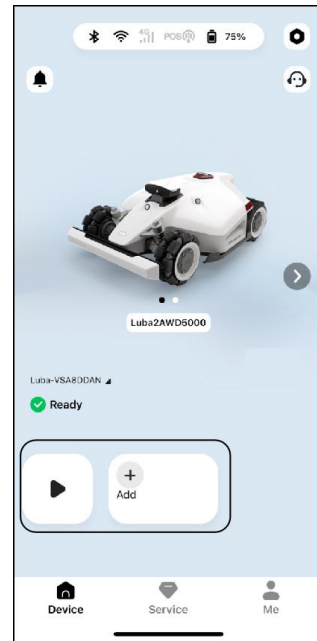

4.6 Map Page Introduction

4.6.1 Create a map

Before mapping

Before mapping, it is important to be aware of key considerations.

- Remove debris, piles of leaves, toys, wires, stones, and other obstacles from the lawn. Make sure no children or animals are on the lawn.
- Luba's status shows **Ready** and the positioning status is good.
- We highly recommend you leave 15 cm/6 in distance if you drive Luba along the edge of a wall/fence/obstacles/ditches.

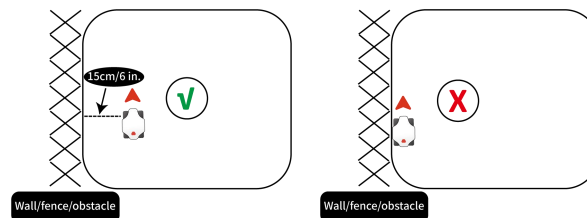

- The controller should follow Luba within 3 m/10 ft to ensure a good Bluetooth connection and for safety reasons.
- Do not drive Luba cross over uneven curbs. However, for improved cutting, guide Luba along the lawn's perimeter on the flat and open curb.

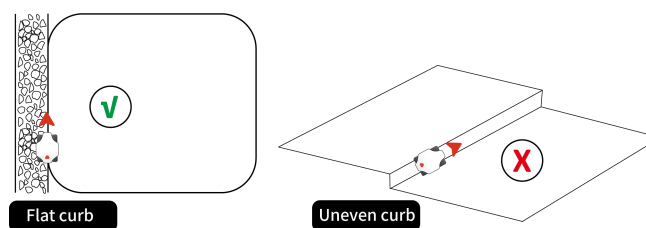

- Please map the task area along the perimeter of the lawn.

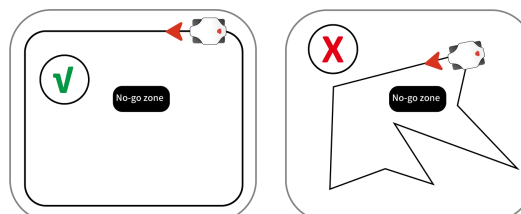

To map your lawn

1. Tap the Luba image to access the Map page in portrait mode.
2. Tap **Map** to access the Map page in landscape mode.

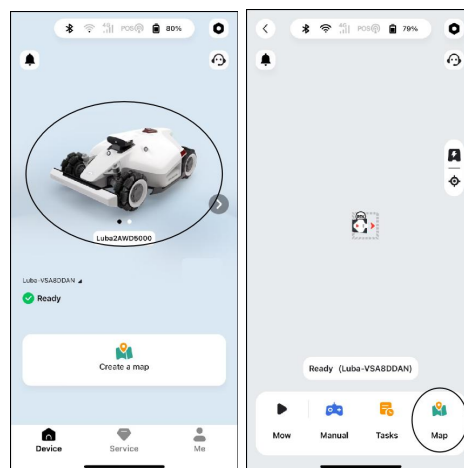

3. Tap **Create > Area** on the Map page.

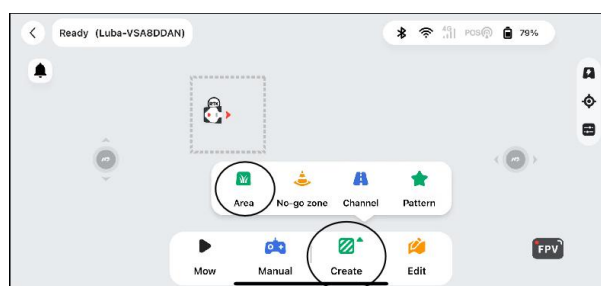

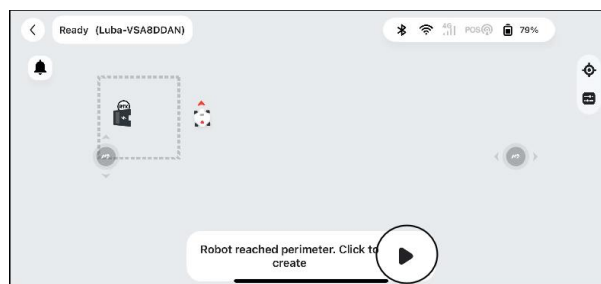

4. Tap ▶ to start drawing. Manually control Luba to draw the perimeter of your lawn.

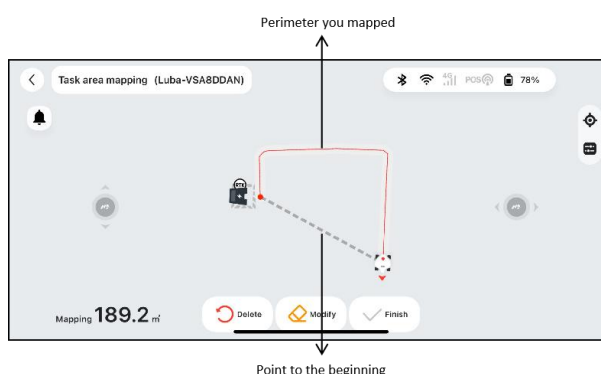

5. The solid line marks the perimeter that you have set, while the dotted line will help you to get back to the starting point. The lawn map will not be created until you control Luba to the starting point.



6. Tap  to adjust the perimeter that has been set if needed. Guide Luba back along the path to the intended location.

7. Control Luba to the start point and tap  to save the setting.

8. Tap  to re-draw the perimeter if needed.

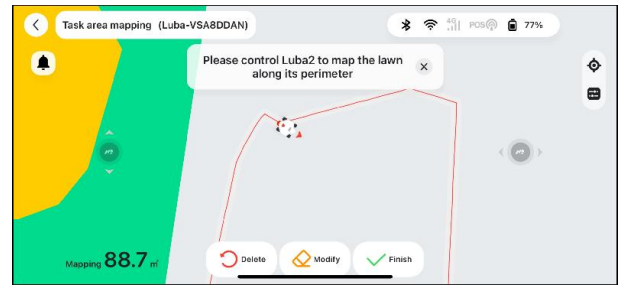

9. Select **Continue mapping** in the pop-up then click **Channel** to add a connection path between your lawn and charging station. It is a must to set a channel between them if the charging station is located outside the lawn.

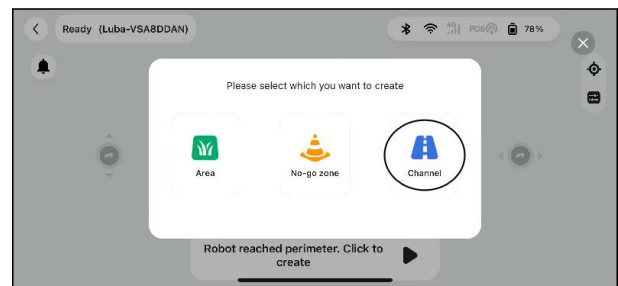
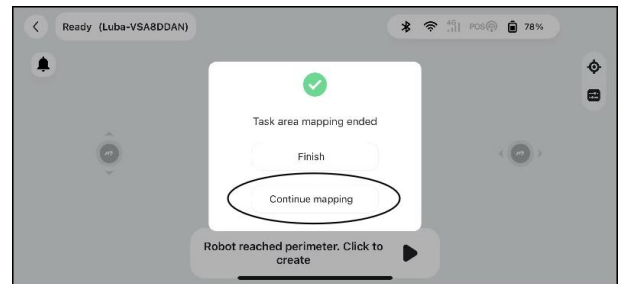



NOTE

- When mapping, the system will estimate the area. Please ensure that the area is not more than the upper limit (See [Technical Specifications](#) for more information), or the task area mapping will fail.
- Drive Luba out of the task area or no-go zone first if a new area is created.

To add a no-go zone

No-go zones are created for pools, flowerbeds, trees, roots, ditches, and any other obstructions present in the lawn. Luba will avoid mowing inside these designated areas.

1. Tap **Create** > **No-go zone** on the Map page.
2. Guide Luba around the perimeter of a no-go zone, then tap  to start drawing.
3. Keep controlling Luba along the perimeter of the no-go zone and back to the start point to complete mapping the no-go zone.
4. Tap  to save the setting.

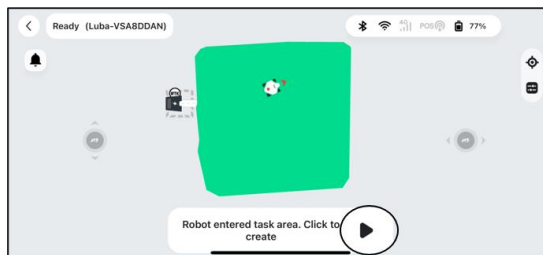
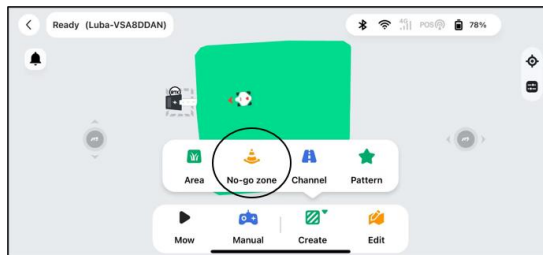



NOTE

- Ensure that Luba has been transported to the appropriate task location when creating a no-go zone.
- Delete the current no-go zone and create a new one if a change is required. To do so, go to **Edit** > **Delete**.

To add a channel

The channel is intended to connect various task areas or link the task area with charging station.

1. Tap **Create** > **Channel** on the Map page.
2. Control Luba inside a task area and tap  to start drawing.
3. Guide Luba from a task area to another or to the charging station.
4. Tap  to save the setting.

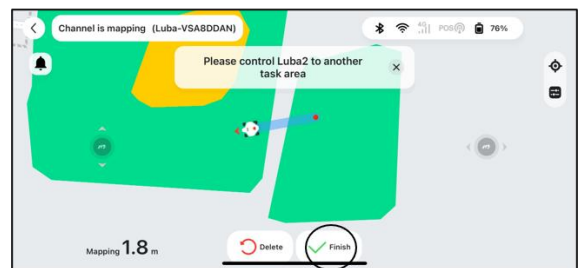
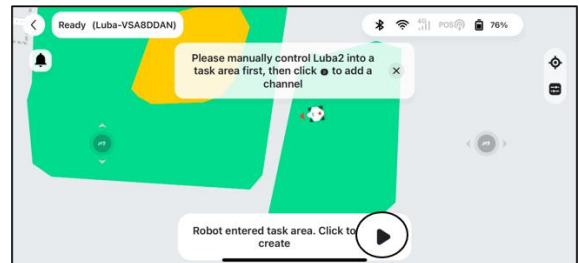
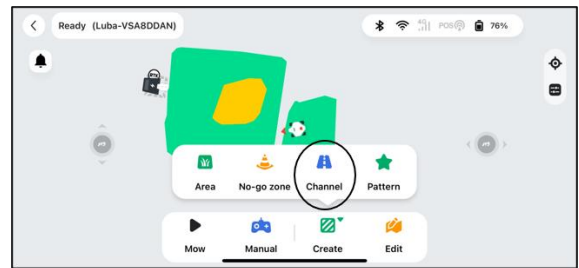

NOTE

- Ensure that Luba has been transported to the appropriate task location when adding a channel.
- Delete the current channel and create a new one if a change is required. To do so, go to **Edit** > **Delete**.

To add a pattern

The pattern is designed to personalize your lawn cutting experience, and after it's added, the grass on the patterned area will be preserved while cutting to maintain its design.

1. Tap **Create** > **Pattern** on the Map page.
2. Choose the pattern that you want to create.
3. Drag and zoom in/out the pattern to adjust its location and size.
4. Tap  to finish the setup.

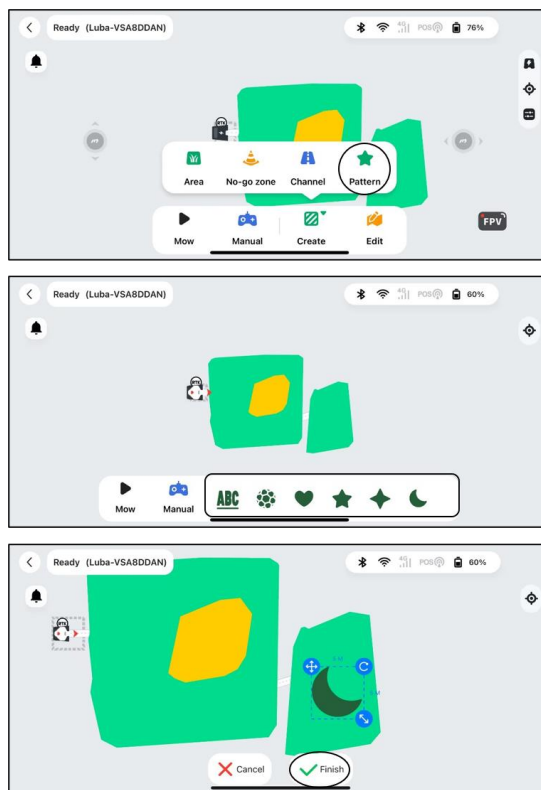

NOTE

- Each task area can have a maximum of 10 patterns, with a total limit of 50 patterns overall.
- The pattern should not be placed too close to the task area perimeter, no-go zone, or charging station. Maintain a minimum distance equal to the width of the robot.

After mapping

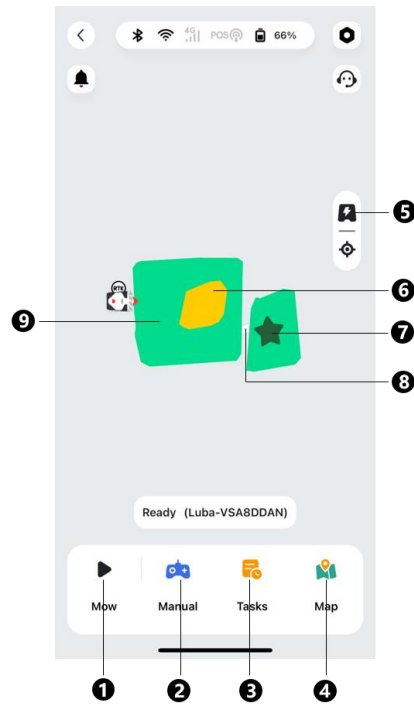

- | | | |
|---------------------|------------------|------------------|
| 1. Automatic mowing | 2. Manual mowing | 3. Task schedule |
| 4. Map management | 5. Recharge | 6. No-go zone |
| 7. Pattern | 8. Channel | 9. Task area |

Map management

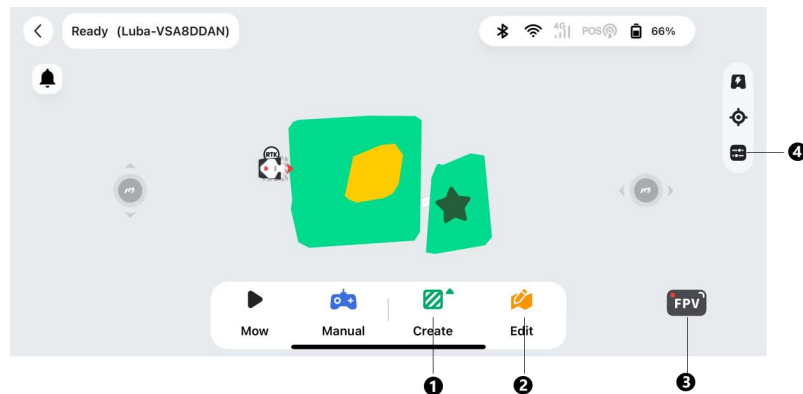



1. Tap to create task area/no-go zone/channel/pattern
2. Tap to edit task area/no-go zone/channel/pattern
3. Tap to enter FPV mode
4. Upper limit speed for manual control

To edit or delete the current task area

➤ To edit the current task area, tap **Edit** to enter the Map editing page.

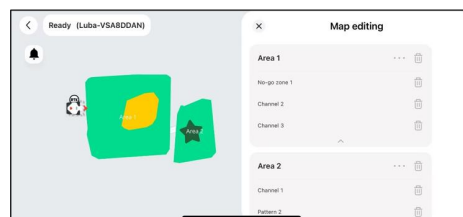
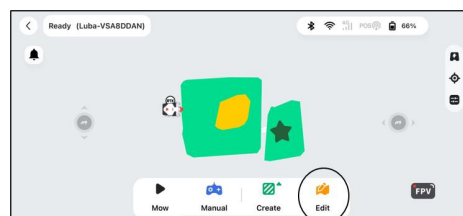
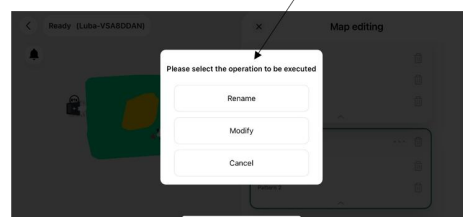
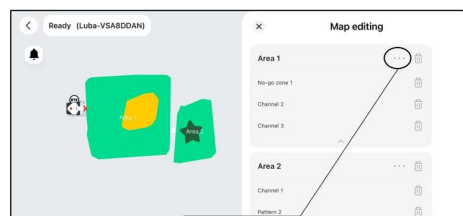
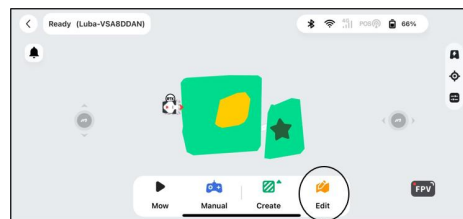
- Tap **Modify** to re-draw the perimeter.
- Tap **Rename** to edit the name of the task area.



➤ To delete a task area, tap **Edit** > **Delete**  to continue.

To delete the no-go zone/channel

➤ To delete a no-go zone/channel, tap **Edit** > **Delete**  to continue.

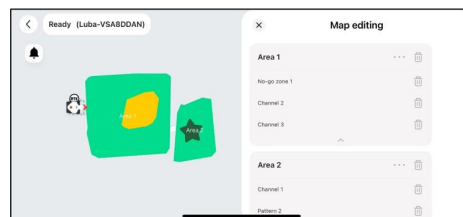
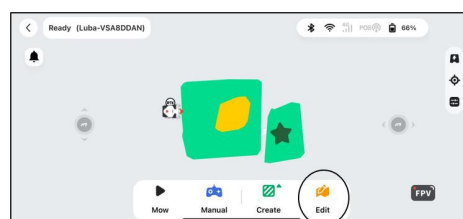

To edit or delete the pattern

- To edit the pattern, tap **Edit** to enter the Map editing page.
 - **Enable** — toggle the button on/off to enable/disable the pattern. After enabling the pattern, the grass on the patterned area will be preserved while mowing to maintain its design.
- To delete a pattern, tap **Edit** > **Delete** 🗑️ to continue.

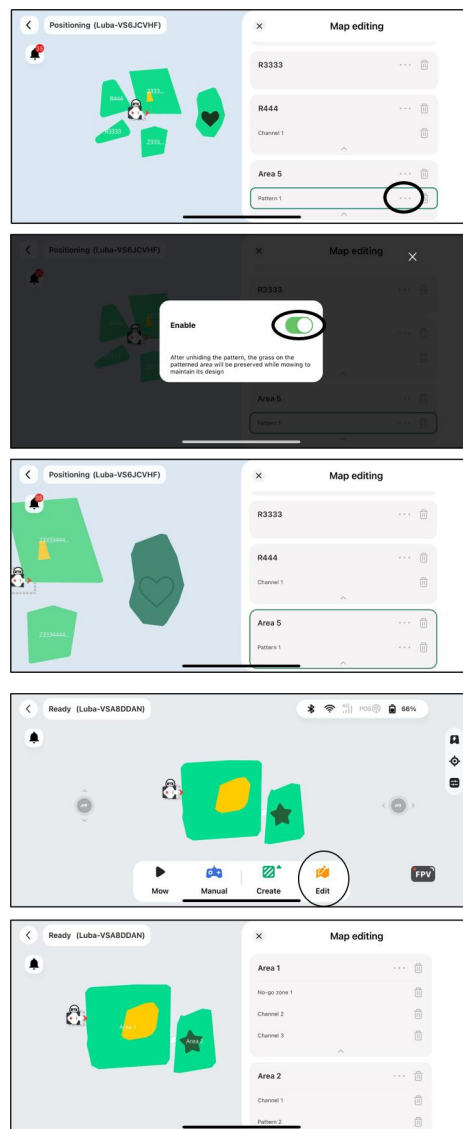

Multiple task areas with overlapping

If you have several lawns that overlap, the shared section will be assigned to the task area that was created first. No channel is necessary for two task areas with overlapping sections.

RTK reference station cannot be moved once your lawn mapping is finished

Do not move the RTK reference station after the map is created or the resulting working area will diverge from the designated task area.

In the event of a RTK reference station relocation, please go to **Settings**  > **Robot settings** > **Delete map** to delete the current map, then remap.

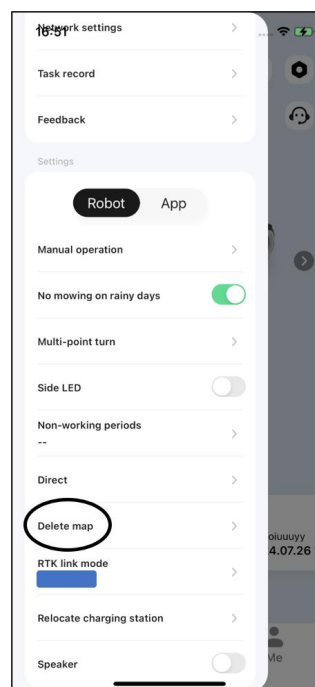

4.6.2 Mow

Preparation

- Ensure Luba is in the task area before mowing.
- If any unexpected problems arise, please press the **STOP** button and secure Luba. The STOP button holds top priority among all commands.
- If the lift sensor is activated, Luba will come to a halt. Please press the **Grass** button followed by the **Start** button to activate Luba.
- Please mow the task area no more than once a day as doing so may be harmful to your lawn.
- If the grass height exceeds 60 mm/2 in, it is advisable to raise the cutting height to at least 40 mm/1.6 in. When mowing, it is important to only trim a third of the grass height each time. For example, if the initial grass height is 60 mm/2 in, the cutting height of Luba should be set to 40 or 45 mm/1.6 or 1.8 in. Similarly, if the grass is between 90-100 mm/3.5-4 in, the cutting height of Luba should be set to 60 mm/2 in.

To start mowing

1. Tap  on the Main page to start mowing settings.
2. Follow the onscreen information to finish the settings and start mowing.

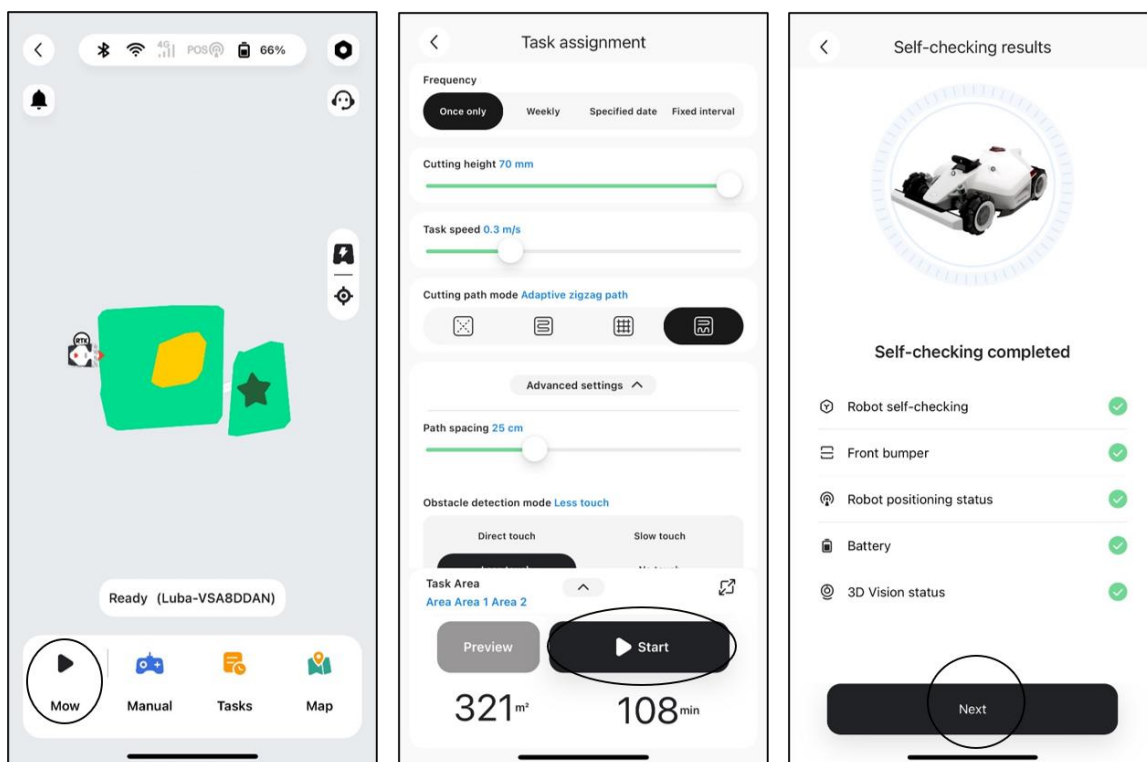

Cutting path mode



Perimeter laps only

Luba will mow the perimeter grass only.



Zigzag path

Luba will mow in straight rows.



Chess board path

Luba will mow in straight rows both horizontally and vertically.



Adaptive zigzag path

The task area will be divided into segments for efficient mowing.

Advanced settings

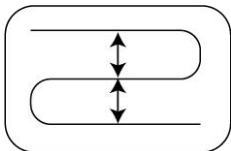
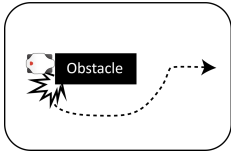
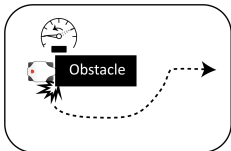
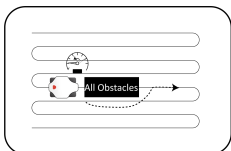
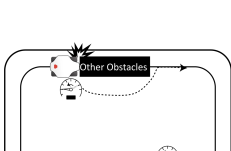
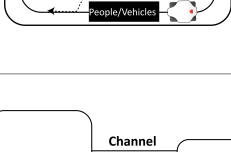
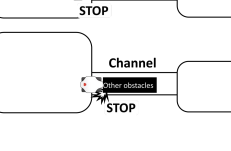
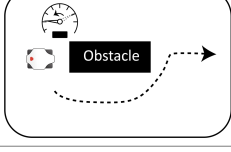
| | | | |
|--------------------------------|--|---|---|
| Cutting height | The height of cutting disks. | | / |
| Task speed | The speed of Luba when mowing. | | / |
| Path spacing (cm) | The spacing between 2 cutting paths. | |  |
| Obstacle detecting mode | Direct touch | Bypass the obstacle after a collision of front bumper. |  |
| | Slow touch | Luba will slow down after detecting obstacles and bypass the obstacles after a collision of front bumper. |  |
| | Less touch | Zigzag path: Luba will slow down and bypass the obstacles after detecting them. |  |
| | | Perimeter: Luba will slow down and bypass people and vehicles after detection; For other obstacles, Luba will perform Slow touch strategy. |  |
| | | Channel: Luba will stop after detecting people or vehicles; For other obstacles, Luba will stop after collision of front bumper. |  |
| | No touch | Luba will slow down and bypass the obstacles after detecting them. |  |
| Perimeter mowing laps | The mowing circles at the perimeter. *In the Perimeter laps only mode, the perimeter mowing laps cannot be set 0. | |  |

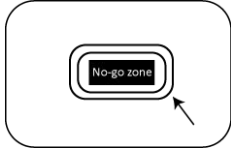
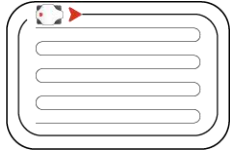
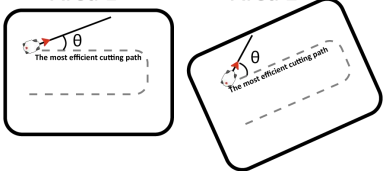
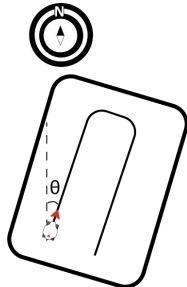
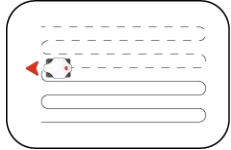
| | | |
|--------------------------------------|--|--|
| <p>No-go zone mowing laps</p> | <p>The grass-cutting circles surrounding the perimeter of the restricted area.</p> |  |
| <p>Perimeter first</p> | <p>Luba starts mowing from the perimeter. *Not available for perimeter laps only mode.</p> |  |
| <p>Cutting path angle (°)</p> | <p>Relative angle: Take the most efficient path recommended by algorithm as the 0-degree direction.</p> | <p>Area 1 Area 2</p>  |
| | <p>Absolute angle: Take the due north as the 0-degree direction.</p> |  |
| <p>Start progress</p> | <p>The starting point for mowing.</p> | <p>E.g. set 50% for start progress</p>  |

When Luba enters an area where RTK signals are weak while mowing

If Luba enters an area where RTK signals are weak while mowing, the multi-sensor fusion positioning system will assist Luba in continuing to operate through the vision module. The vision navigation can last for 50 meters/164 feet. Luba should return to an area covered by RTK signals before the vision navigation reaches its limit, otherwise, Luba will come to a stop.

4.6.3 Task schedule

With the Schedule function, you can set a regular task and Luba will automatically do its work according to your setting.

- **Once only** — Luba will commence work promptly upon configuration.
- **Weekly** — Luba will repeat the task every week based on your preferences.
- **Specified date** — Luba is scheduled to commence work on the specified date.
- **Fixed interval** — specify non-working days. For example, if you input 3 days, Luba will operate once every 3 days as per your settings.

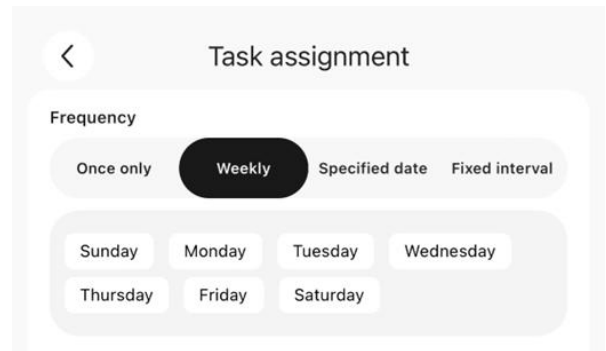

To set a schedule

NOTE

- The task schedule adding is temporarily disabled when Luba is working.
- A schedule can be set after a task area has been created.

1. Tap + on the main page.
2. Follow the onscreen information to set time, frequency, work area, and advanced settings. Tap **Start/Save** to complete the setup. Or tap **Preview** to preview the results if needed.

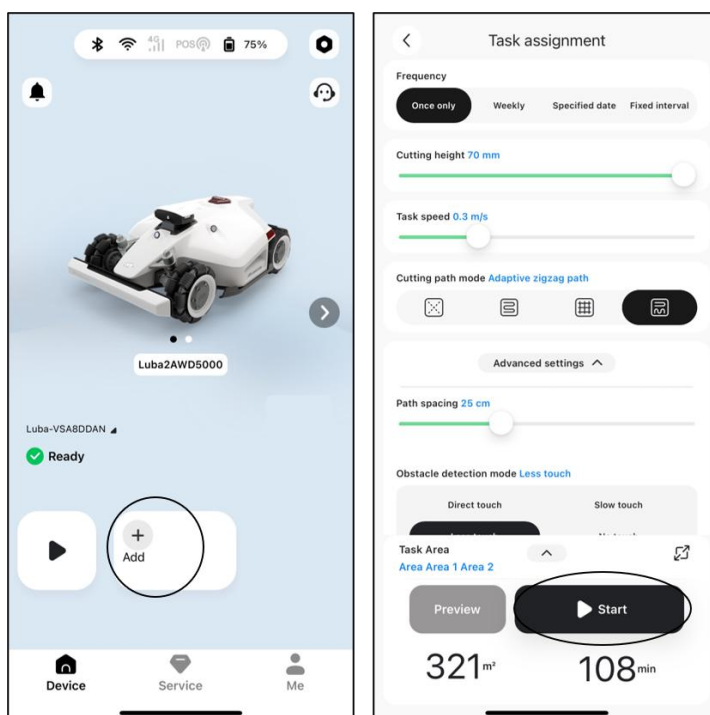

NOTE

For initial use of Luba, we strongly advise setting the cutting height to above 50 mm/2 in.



To change/delete a schedule

Tap **⋮** on the schedule you set to open the drop-down menu.

- **Enable** — toggle the button  to off  to inactivate the schedule if needed.
- **Rename** — tap to change the name of the schedule.
- **Edit** — tap to change the schedule.
- **Run now** — tap to run this schedule immediately.
- **Copy** — tap to create a new schedule with the same settings while keeping the original schedule, then choose one to edit.
- **Delete** — tap to delete the schedule.

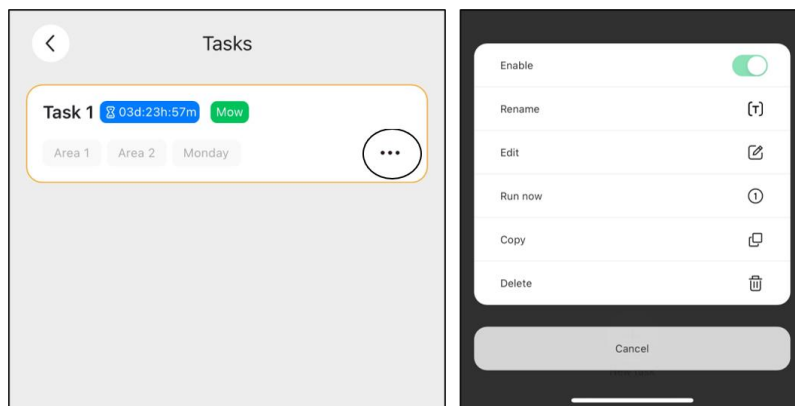

4.6.4 Manual operation

To ensure your safety, please use the **Manual mowing** function with care and observe the following:

- Minors are not permitted to use this function;
- Please always supervise your children, pets and important belongings to prevent accidents;
- Take extra care when using the manual lawn mower function to avoid injury.

Manual operation page introduction

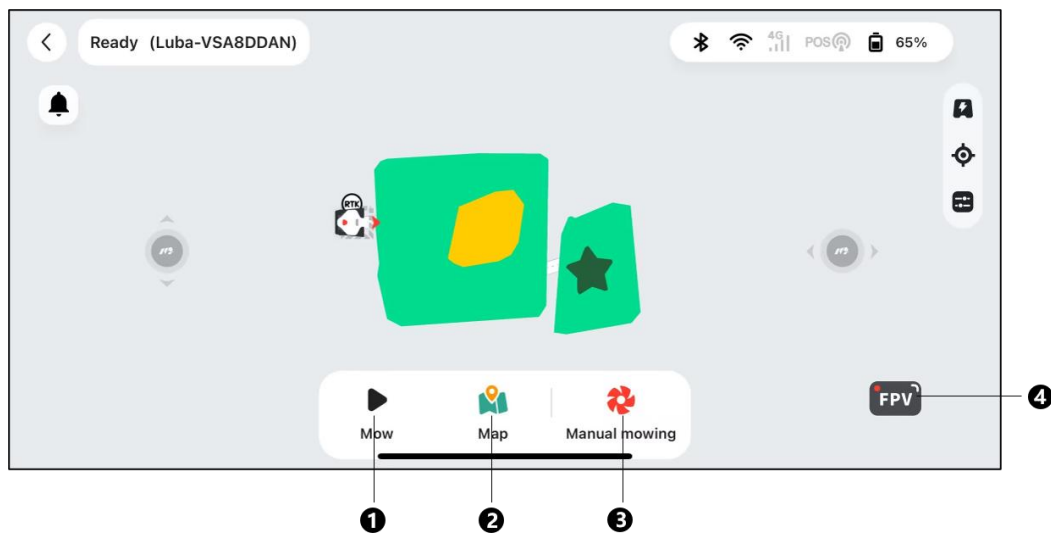

1. Automatic mowing
2. Map management
3. Start manual mowing
4. Switch to FPV mode

To activate manual mowing

1. Tap the Luba image to enter the Map page.
2. On the Map page, select **Manual**.
3. Tap **Manual mowing**, then drag the button to the right to start the cutting disk.
4. Maneuver forwards/backwards or turn left/right to start working.

NOTE

- The cutting disk will automatically stop after 5 seconds of inactivity.
- Drag to the right as prompted by the app to start the cutting disk after each stop.

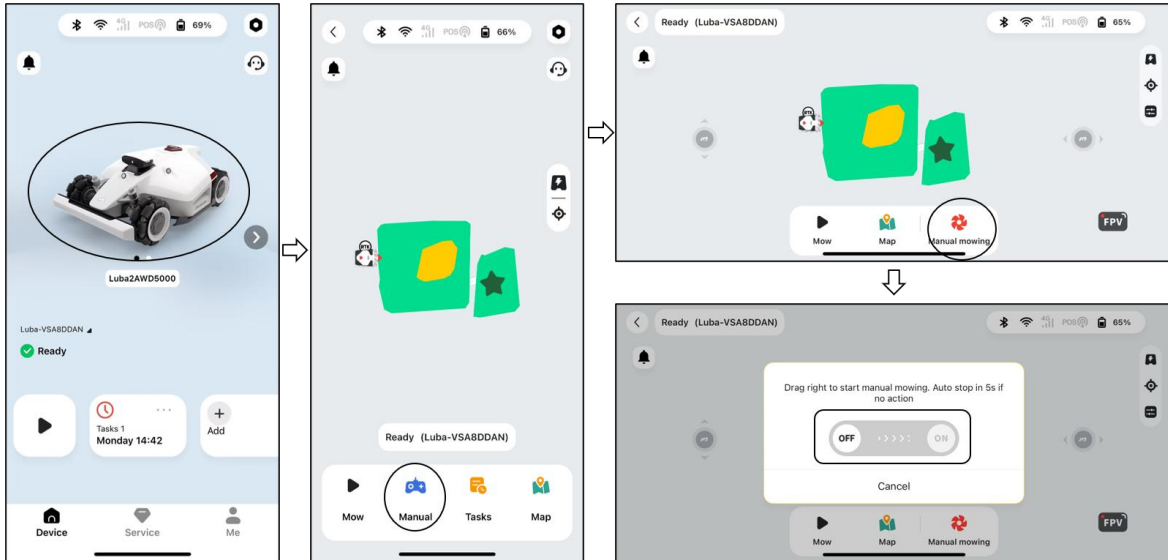

4.6.5 Status bar

From left to the right:

- Bluetooth
- Luba's Wi-Fi
- Cellular strength
- Positioning status
- Luba battery status



Tap the status bar to show the following details.

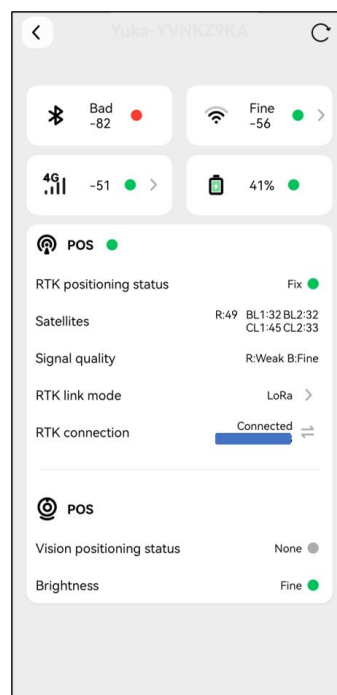

- **Positioning status** — shows the strength of satellite positioning.
 - ✧ **Fix** — fine positioning status with an accuracy of less than 10 cm/4 in, up to 2 cm/1 in with a good open-sky area.
 - ✧ **Float** — poor positioning status with an accuracy about 50-200 cm/20-79 in.
 - ✧ **Single** — bad positioning status with a meter-level accuracy.
 - ✧ **None** — no positioning status.

**Only Fix status enables automatic mowing.*
- **Satellites** — refers to the total number of satellites received by Luba and RTK reference station.

- ✧ **R** stands for the number of satellites received by Luba.
- ✧ **B** stands for the number of satellites received by RTK reference station.
- ✧ **C** stands for the number of co-viewing satellites received by both Luba and RTK reference station.
- ✧ **L1** and **L2** respectively indicate the satellites operating at L1 and L2 frequencies.
- **Signal quality**
 - ✧ **R** stands for satellite signal strength of Luba.
 - ✧ **B** stands for satellite signal strength of RTK reference station.

*The accuracy of positioning is affected by the quality of the satellite signal and the number of Co-Viewing satellites. Objects such as trees, leaves, walls, and fences can weaken the signal and lead to positioning errors. Despite detection of more than 20 satellites by both the Luba and RTK reference station, the signal quality can still be deemed as Weak or Bad.
- **RTK link mode** — offers two connection modes: LoRa and Internet RTK. See [To switch RTK link mode](#) for more information.
- **RTK connection** — indicates the connection status of RTK reference station.
- **Vision positioning status** — shows the strength of vision positioning.
 - ✧ **Fine** — Vision positioning is optimal.
 - ✧ **Bad** — vision positioning is poor.
 - ✧ **Initialization** — vision module is initializing.
 - ✧ **None** — no vision positioning available.
- **Brightness** — shows the strength of ambient light.
 - ✧ **Fine** — ample brightness for vision positioning.
 - ✧ **Dark** — insufficient brightness; vision positioning cannot operate.

To switch RTK link mode

RTK link mode refers to the method of connection between an RTK reference station and a Luba. There are two primary modes: **LoRa** and **Internet RTK**.

LoRa involves data communication between the RTK reference station and the Luba using radio antennas. On the other hand, Internet RTK utilizes the internet for data communication between the RTK reference station and the Luba. Internet RTK significantly expands the range of RTK applications, enabling operation over large geographical areas.

Switch LoRa to Internet RTK

IMPORTANT

- Internet RTK relies on a stable 4G network. It is crucial to ensure that Luba maintains a reliable 4G connection.
- Please ensure that both Luba and RTK reference station are bound to the same account.
- For optimal operation, it is recommended to update both Luba and RTK reference station firmware to the latest versions.

1. Verify the 4G icon on the Status bar to illuminate, indicating successful activation of the SIM card. Tap the Status bar to access the status information page.
2. The current RTK link mode is LoRa. Tap it to access RTK link mode page. Select **Internet** and tap the RTK reference station to configure your network.

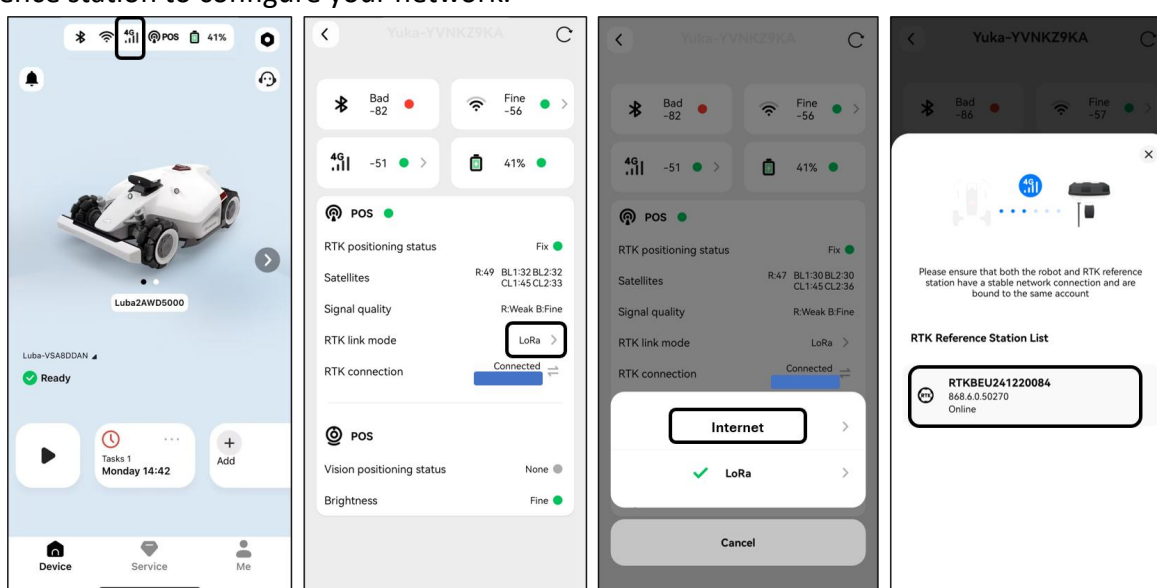

- Wait for a green check mark to appear, then return to the status information page. Verify that the RTK positioning status displays 'Fix' and the RTK connection shows 'Connected'. Your setup is now complete.

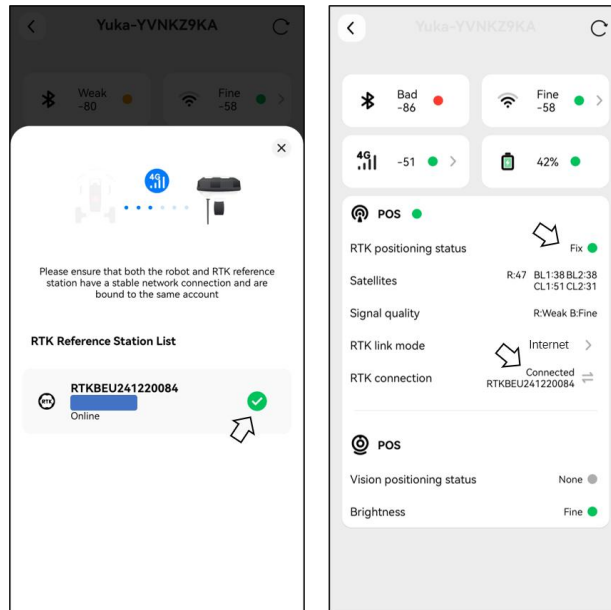

Switch Internet RTK to LoRa

- Tap the Status bar to access the status information page.
- The current RTK link mode is Internet. Tap it to access RTK link mode page. Select **LoRa**, and ensure the displayed LoRa number matches the one on the RTK reference station's nameplate. If not, input the correct one. Tap **OK** to proceed.

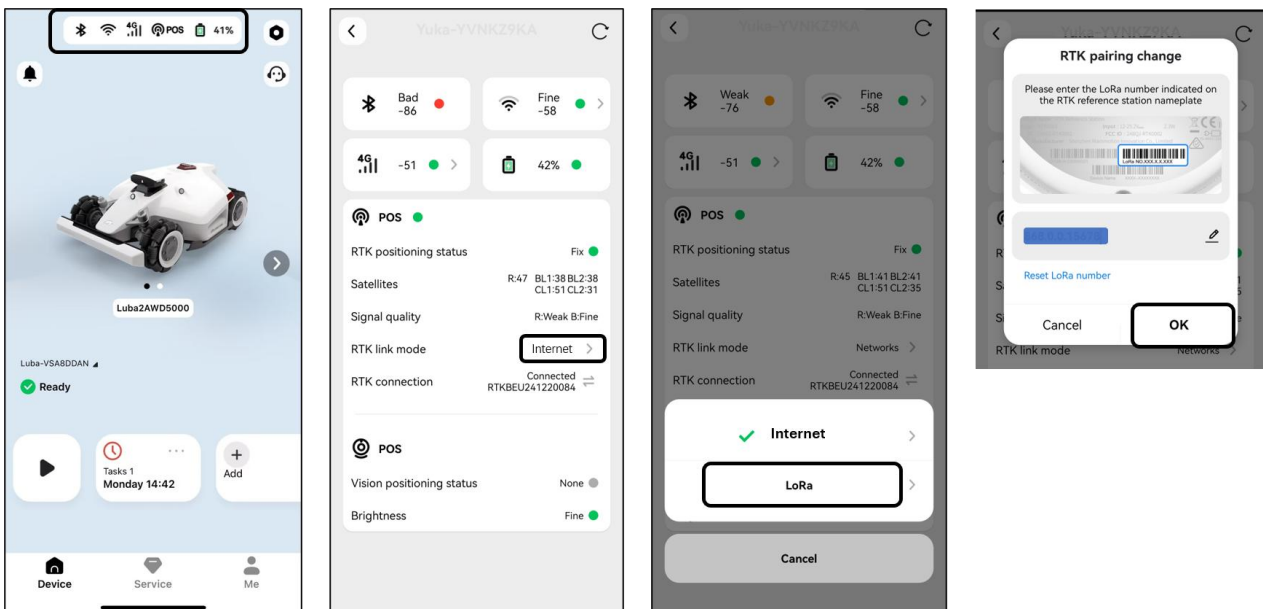

3. Return to the status information page and verify that the RTK link mode displays '**LoRa**', the RTK positioning status shows '**Fix**', and the RTK connection status shows '**Connected**'. Your setup is now complete.

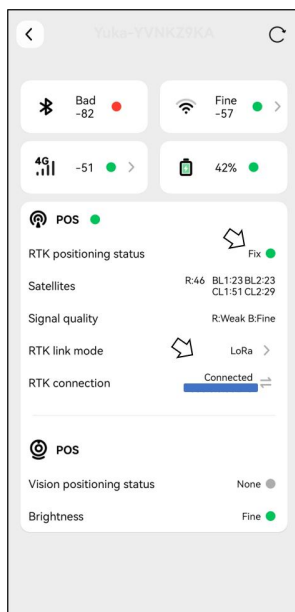

What to do when the Luba's positioning is not Fix.

- Satellites (B): L1 < 20, L2 < 20
- Satellites (C): L1 < 20, L2 < 20
- Positioning status: Float

Measures:

Place the RTK reference station in an area with unobstructed views of the sky, without any physical obstructions within at least 5 m/16 ft. Alternatively, position the RTK reference station on a wall or roof.

- Signal quality (B): Bad or Weak
- Positioning status: Float

Measures:

Place the RTK reference station in an area with unobstructed views of the sky, without any physical obstructions within at least 5 m/16 ft. Alternatively, position the RTK reference station on a wall or roof.

- Satellite (B): L1:0, L2:0
- Satellite (C): L1:0, L2:0
- Positioning status: Single

Measures:

- ✓ Ensure the power supply to the RTK reference station is functioning normally.
- ✓ Verify that the indicator on the RTK reference station remains a constant green between the hours of 8:00-18:00 local time.
- ✓ Check for any defects within the RTK reference station, such as water leaks.
- ✓ Confirm that the radio antenna has been installed.
- ✓ Re-pair the RTK reference station and Luba to see if it can be fixed.
- ✓ If you replace the RTK reference station, pair the new station with Luba on the Mammotion app. For more details, visit <https://mammotion3006.zendesk.com/hc/en-us/articles/16503733641367>

- Satellites (R) < 25
- Satellites (C): L1 < 20, L2 < 20
- Positioning status: Float

Measures:

Check if the area where the Luba is situated, particularly when the Luba is being charged, has tall trees/walls/metal barriers, etc.

- Signal quality (R): Bad or Weak
- Positioning status: Float

Measures:

- ✓ Check if Luba's current location is fully or partially covered.
- ✓ If the Luba is positioned on the charging station, relocate it to a less obstructed area.
- ✓ If the Luba is located on the perimeter/corner of the task area, adjust the perimeter/corner to ensure it is not covered.
- ✓ If Luba is located within the task area and has lost its positioning due to obstacles such as trees, iron tables or chairs, mark those obstacles as no-go zones.

- Satellites (R): 0
- Satellites (C): L1:0, L2:0
- Positioning status: None

Measures:

Check whether the Luba is inside or if its rear is covered with metal. If the Luba is faulty, please contact our after-sales team at https://mammotion3006.zendesk.com/hc/en-us/requests/new?ticket_form_id=13773144519703

- Satellites (B): L1:0, L2:0
- Satellites (C): L1:0, L2:0
- Positioning status: Float
- Signal quality (B): None

Measures:

- ✓ Check if the RTK reference station has powered off.
- ✓ If the Luba is too far from the RTK reference station, narrow the distance between the RTK reference station and Luba and retry.
- ✓ Verify if there are any malfunctions with the antenna, RTK reference station, or Luba receiver. If so, please contact our after-sales team at https://mammotion3006.zendesk.com/hc/en-us/requests/new?ticket_form_id=13773144519703

4.6.6 Customer service

The Customer Service provides an internet-based chat service for any inquiries you may have and receive prompt responses from our technical support team. Simply click on **Chat to Agent** to start a conversation with one of our representatives.

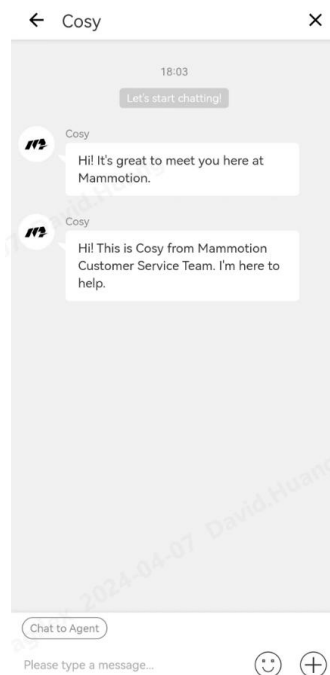

4.6.7 Track your devices

In the case that your Luba or RTK reference station that has been bound with the Mammoth app is missing, go to **Service > Find my Device** page to track your device.

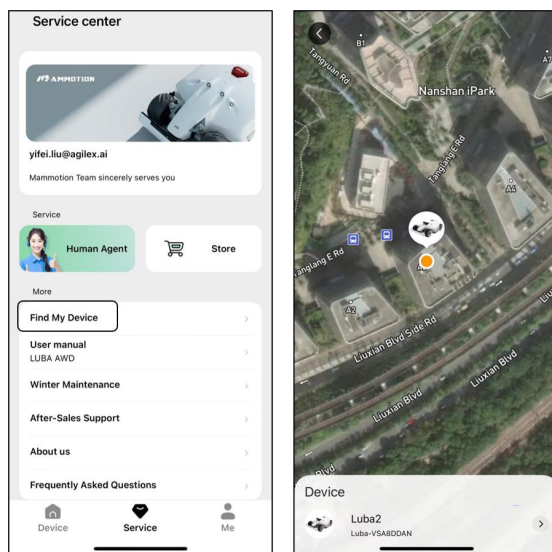

4.6.8 Notification

Information regarding the status, any errors, etc. will be displayed in the notification section. Tap  in the upper-right corner to check the historical records.

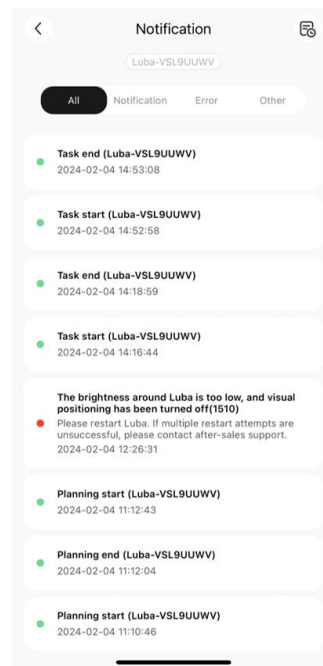

4.6.9 Settings

Tap  to enter the Settings page.

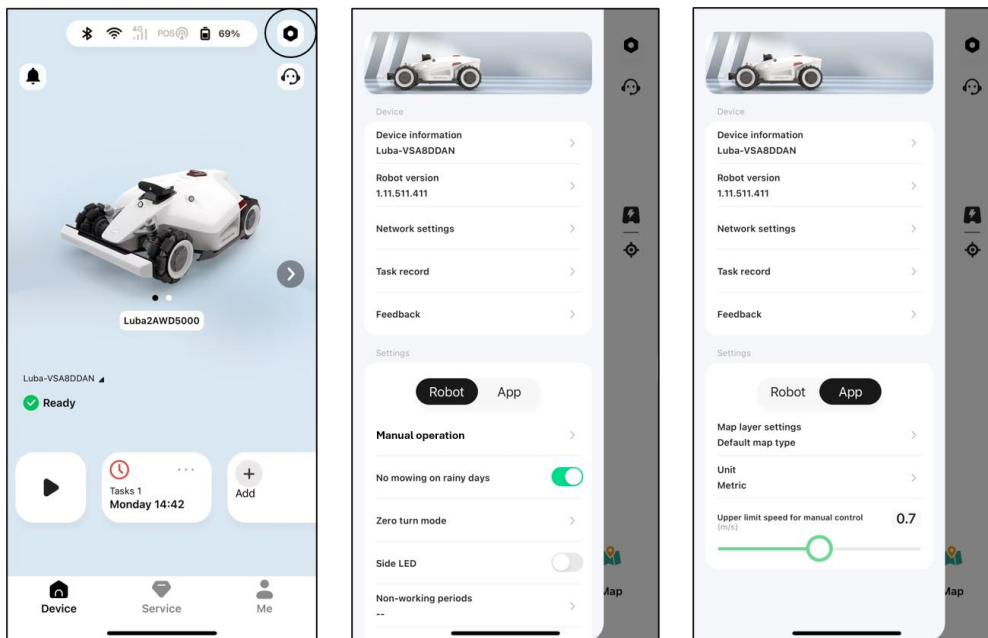

Device settings

- **Device information**

- ✧ **Device name** — change the name of Luba.
- ✧ **Sharing management** — tap to view your sharing history and share your device with your family.
- ✧ **Robot version** — check the firmware version of Luba.
- ✧ **Network settings** — set Luba network.
- ✧ **Feedback** — tap to send your issues and logs to Mammotion to target. You can attach a maximum of 5 images and 1 video.
- ✧ **Factory reset** — tap to perform factory reset. All the logs and Wi-Fi passwords will be clear.
- ✧ **Maintenance** — shows the information of total mileage, mowing duration, battery cycle, and activation time.
- ✧ **Unbind** — tap to unbind the current Luba. A set of Luba can only be associated with one account and cannot be operated until it is bound. If you wish to transfer ownership of the Luba, you must unbind it before proceeding.

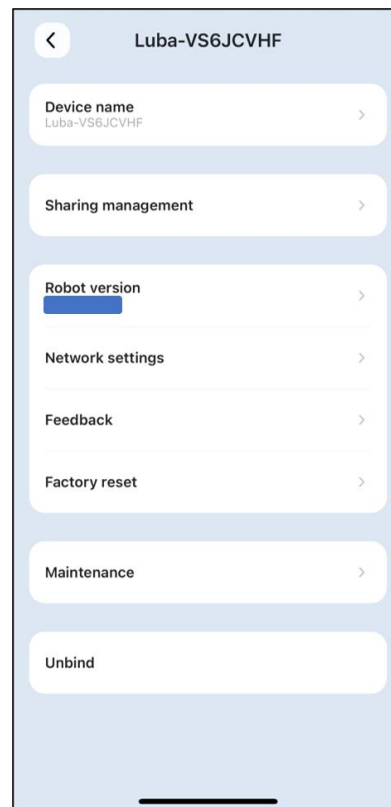

- **Robot version** — check the firmware version of Luba or upgrade it if any.
- **Network settings** — set Luba network.
- **Task record** — shows the historical tasks which were completed and uncompleted.
- **Feedback** — tap to send your issues and logs to Mammotion to target. You can attach a maximum of 5 images and 1 video.

Robot settings

- ✧ **Manual operation** — tap to enter manual mowing mode. See [Manual operation](#) for details.
- ✧ **No mowing on rainy days** — when you enable this function, the Luba will not mow if it rains.
- ✧ **Turnaround mode** — Zero turn and Multi-point turn.

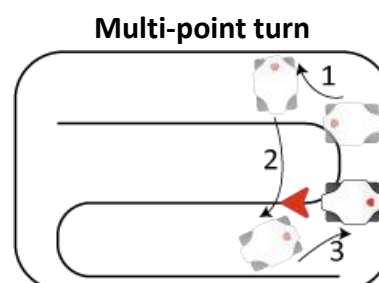
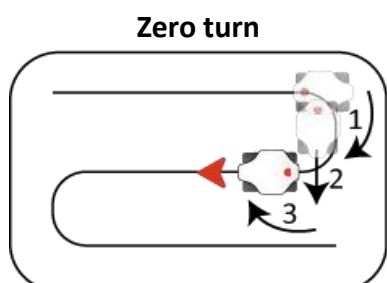

- ✧ **Side LED** — tap to turn on/off the side indicator of the Luba.
- ✧ **Delete map** — tap to delete the task area you create.
- ✧ **Recharge route** — provides two ways to recharge: **Direct** or **Follow the perimeter**; **Direct** means that the Luba takes the shortest route to return to the charging station; **Follow the perimeter** means that the Luba drives down the perimeter to the charging station without leaving any tracks on the lawn.

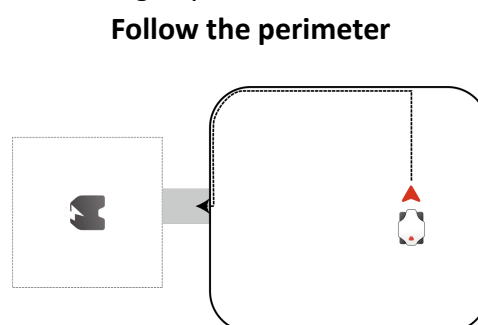
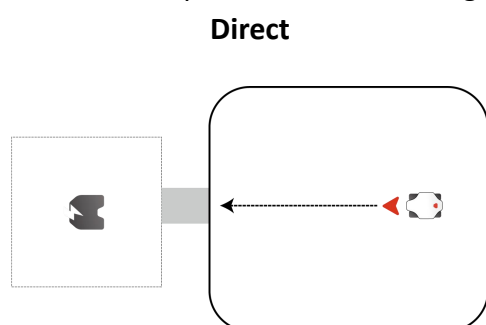

- ✧ **Non-working periods** — tap to set non-working period.
- ✧ **RTK link mode** — tap to switch RTK link mode or reset RTK pairing code.
- ✧ **Relocate charging station** — tap to relocate the charging station. See [To relocate the charging station](#) for additional information.
- ✧ **Speaker** — tap to turn on/off voice prompts.

To relocate the charging station

NOTE

Please relocate the charging station while Luba is charging.

Generally, the charging station should be relocated if

- The charging station and RTK reference station are moved.
 - The docking path has a significant incline.
 - The recharge process consistently fails.
1. Install the RTK reference station/charging station in a proper place.
 2. Place Luba on the charging station and ensure the positioning status is fine.
 3. Select **Settings**  > **Relocate charging station**.
 4. Any existing task areas and schedules will be deleted as the entire system will be changed.

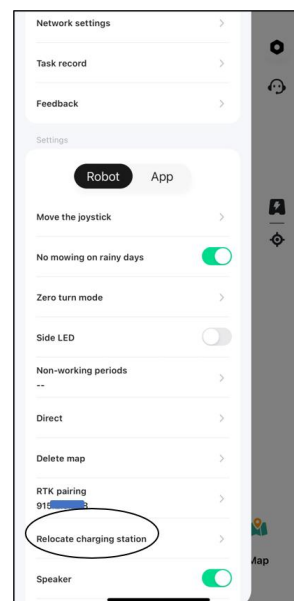



4.6.10 Recharge

NOTE

When performing recharge function, Luba must be in the task area.

To perform recharge

- Tap  on the map page in Mammotion app, or
- Press the button  on the Luba, then press  to guide Luba to the charging station.

4.7 Service

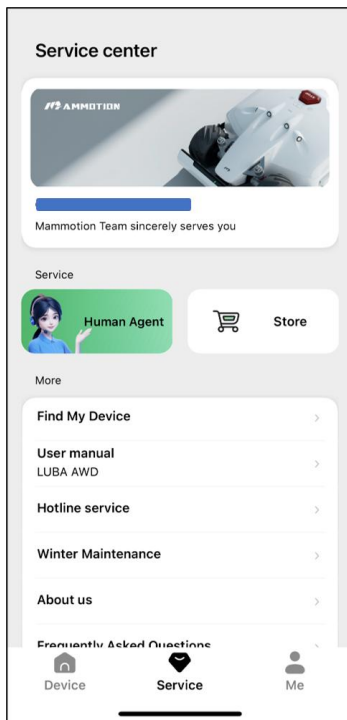

- **Find My Device** — tap to track your missing device.
- **User Manual** — tap to access the user manual.
- **Hotline Service** — tap to call our after-sales support.
- **Winter Maintenance** — tap to access the winter maintenance details.
- **After-sales Support** — tap to submit your request.
- **About Us** — tap to access more information about Mammoth.
- **Frequently Asked Questions** — shows common questions and answers.

4.8 Me

- **Guide** — toggle to on/off to show/hide guidelines.
- **Version Number** — shows the app version.
- **Language** — switch language.
- **Device Management and Sharing** — tap to share your devices.
- **Account Security** — shows the account and security and log out the current account.
- **Feedback** — submit your issues and logs to Mammotion to target.
- **Privacy Agreement** — tap to access the full details.
- **User Manual** — tap to access the user manual.
- **Tutorial Videos** — tap to access installation and operation videos.
- **Forum** — tap to go to forums.
- **After-sales Support** — tap to submit your request.
- **Store** — tap to go to Mammotion mall.
- **Alexa** — tap to link your Alexa account.

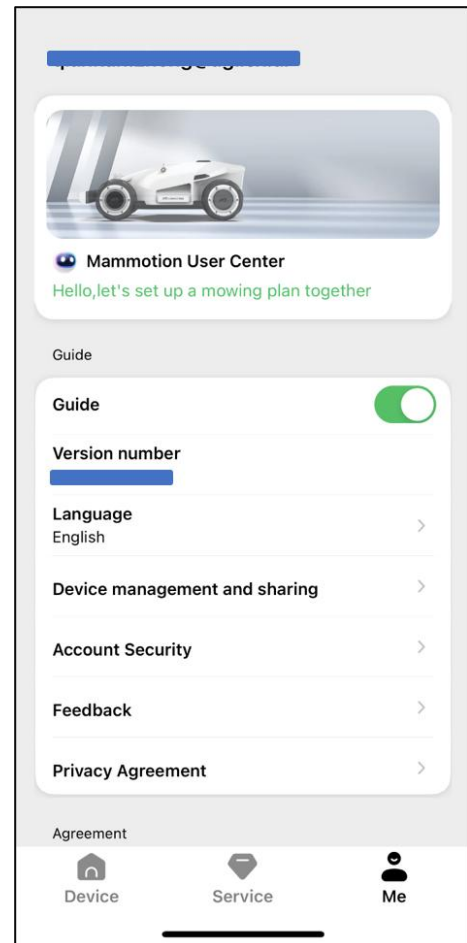

4.8.1 To share your device

Sharing your device allows the recipient to control and access device information, but they cannot share it further or use its anti-theft feature.

1. Go to the Me page and tap **Device management and sharing**.
2. Select your own device to share.
3. Tap **Share with people** to go on.
4. Select **Share via account** or **Share via QR code** to share your device.
 - **Share via account**
 - a. Tap **Share via account**.
 - b. Enter the account number that you want to share, then tap **Share**.

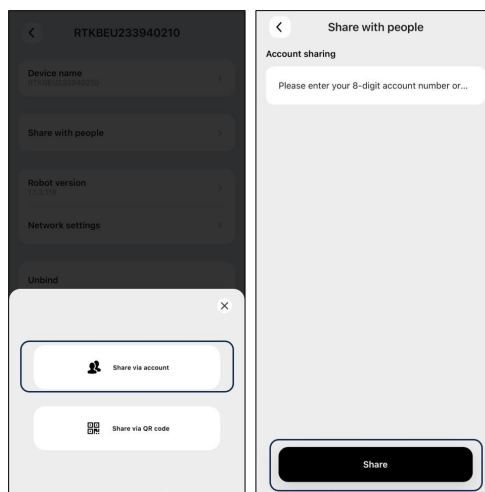
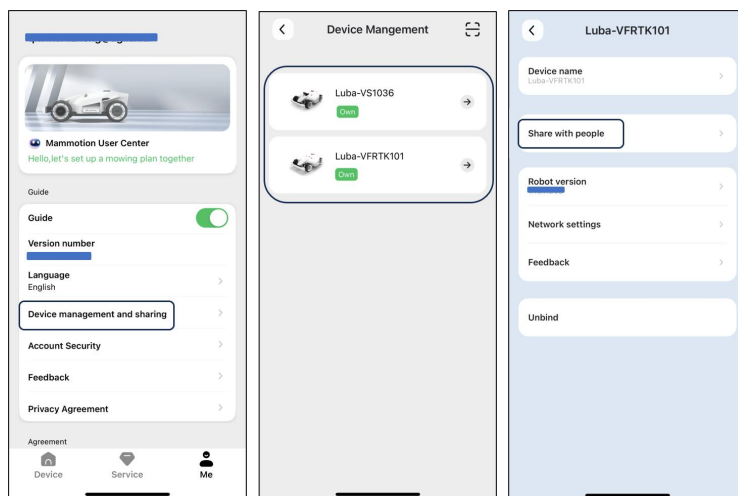

- c. In the recipient's Mammoth app, tap **Agree** in the popup.

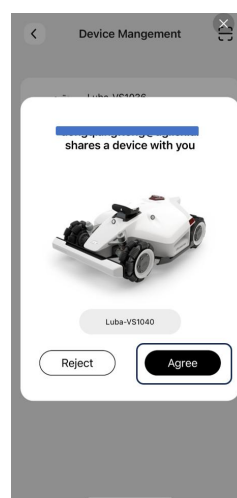

- **Share via QR code**

- Tap **Share via QR code** and a code will appear.

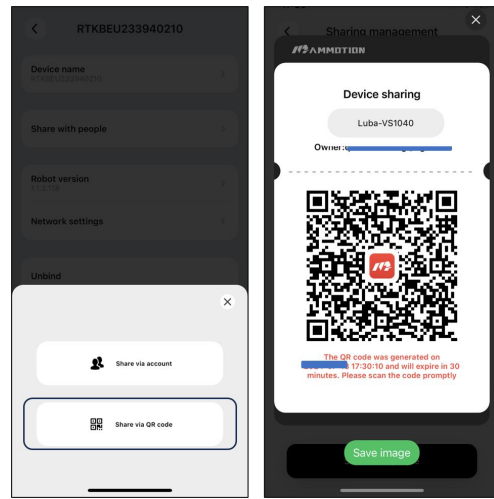

- Use the recipient's Mammoth app to scan the QR code and tap **Agree** in the popup.

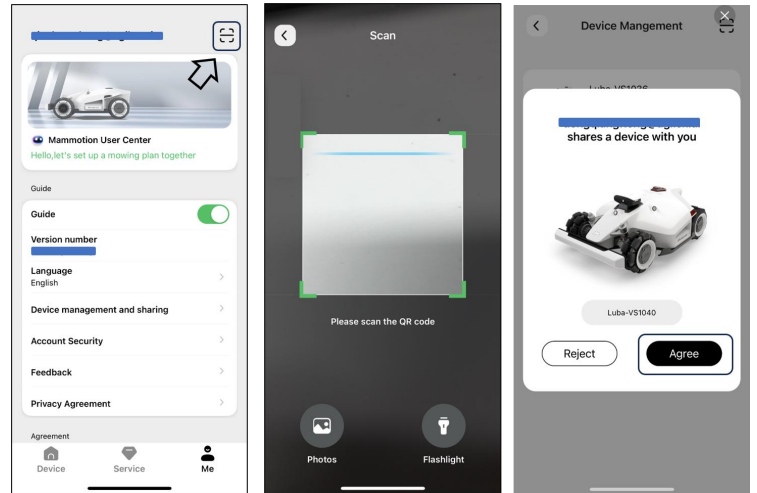

4.8.2 To stop sharing your device

For owner

- Go to the **Me** page and tap **Device management and sharing**.
- Select the device that you have shared.
- Tap **Sharing management** to continue.

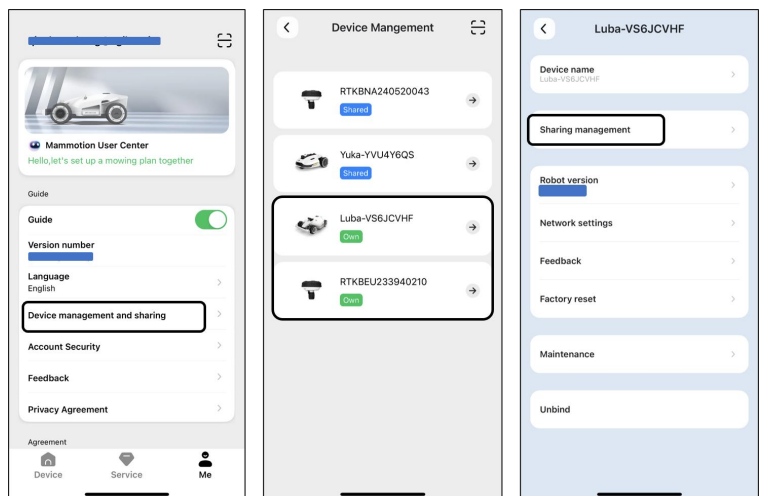

4. Select the corresponding sharing history and tap **Delete**.
5. Tap **Confirm** to revoke the recipient's access to the device.

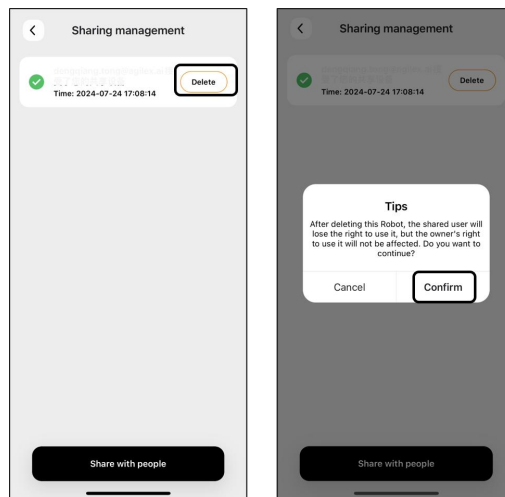

For recipient

1. Go to the Me page and tap **Device management and sharing**.
2. Select the device that has been shared with you.

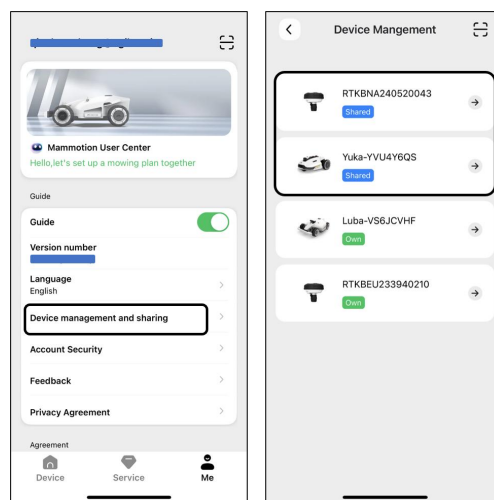

3. Tap **Delete**.
4. Tap **Confirm** to stop using the device. This action will not affect the owner's data.

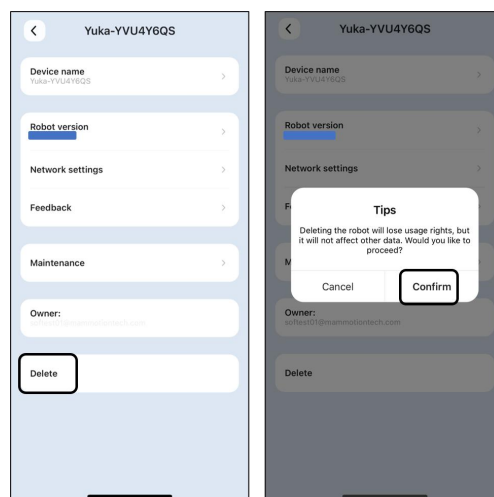

4.8.3 To link your Alexa account

NOTE

- Prior to starting a job using voice control, it is necessary to have created at least one task beforehand.
- In cases where more than 2 sets of Luba are linked to the same Mammotion account, the voice command will be directed to the most recently bound Luba by default.

1. Go to the **Me** page and tap on **Alexa**.
2. Select **Luba 2** to proceed.
3. Tap **Link Alexa** to go to the authorization page.
4. Finally, tap **Link** to complete the operation.

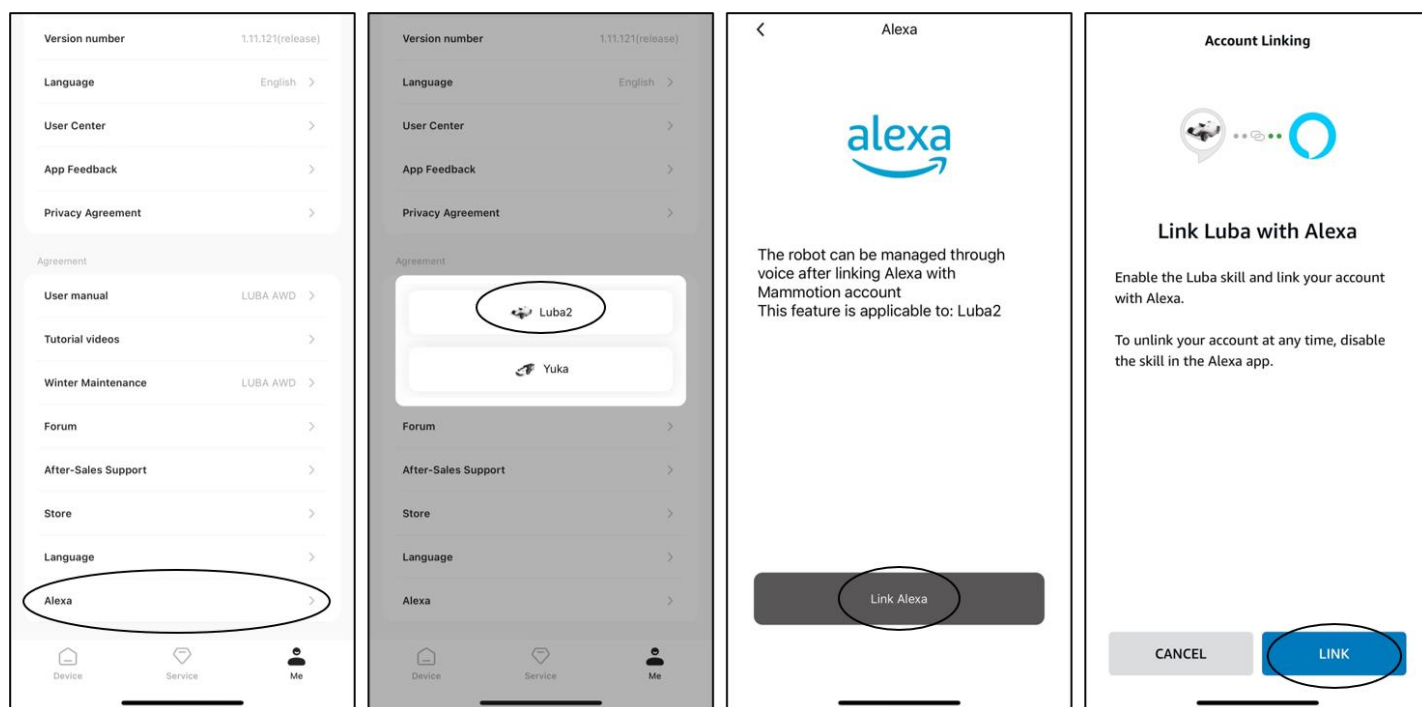

5 Maintenance

5.1 Maintenance for Motors and Cutting Blades

CAUTION

1. Wear protective gloves when you inspect, clean or replace the cutting blade.
 2. Only use the right type of screws and original blades as approved by Mammoth.
 3. All the cutting blades and their screws should be replaced at the same time for a safe cutting system.
 4. DO NOT reuse the screws, which may cause serious injury.
- After mowing task is finished, turn off Luba and flip it over on a relatively soft surface. Then use a brush or faucet to clean the clippings, twigs or leaves from the bottom. Make sure the cutting blade disks are clean and will not get struck.
 - If Luba is stored for a long time, it will be better to add anti-rust oil on the cutting blades after cleaning.
 - Keep the hub motors shaft dry and clean for long-term storage.
 - The cutting blades are recommended to replace every 3 months or after 150-hour mowing. For thick grass, the cutting blade may need to be changed more frequently.

How to replace a cutting blade

1. Remove the old cutting blades.
2. Install the new cutting blades using the included washers (B) and screws (A).

Tool needed: Phillips screwdriver

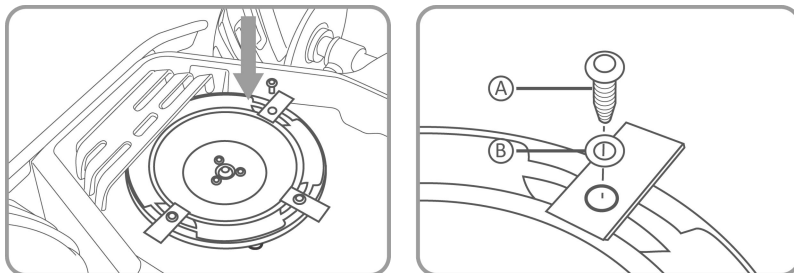

6 Product Specifications

6.1 Technical Specifications

Table 6- 1 Standard Version Specifications

| Standard Version (Cutting Height: 25-70 mm/1-2.7 inches) | | | | |
|--|--|--------------------------------------|--------------------------------------|--------------------------------------|
| Specifications | LUBA 2 AWD | | | |
| | 10000 | 5000 | 3000 | 1000 |
| Max. Mowing Size | 10,000 m ² / 2.5 acres | 5,000 m ² / 1.25 acres | 3,000 m ² / 0.75 acres | 1,000 m ² / 0.25 acres |
| In-App Area Storage Capacity | 12,000 m ² / 3 acres | 6,000 m ² / 1.5 acres | 3,500 m ² / 0.9 acres | 1,200 m ² / 0.3 acres |
| Max. multi-zone Management | 60 | 30 | 20 | 10 |
| Engine | All-wheel Drive (AWD) | | | |
| Max. Climbing Ability | 80% (38.6°) | | | |
| Max. Slope at the Edge | 45% (24°) | | | |
| Vertical Obstacle Passing Ability | 50 mm/2 in. | | | |
| Cutting Width | 40 cm/15.7 in. | | | |
| In-App Cutting Height Adjustment | 25-70 mm/1-2.7 in. | | | |
| Charging Time | 150 min | | | 90 min |
| Mowing Time per Charge | 180 min | | | 120 min |
| Auto-recharge | YES | | | |
| Positioning & Navigation | 3D Vision & RTK | | | |
| Obstacle Avoidance | 3D Vision & Ultrasonic Radar & Physical Bumper | | | |

| Standard Version (Cutting Height: 25-70 mm/1-2.7 inches) | | |
|--|---|--------------------|
| Voice Control | Alexa & Google Home | |
| Vision Monitoring | YES | |
| Connectivity | 4G & Bluetooth & Wi-Fi | |
| Noise Level | 60 dB | |
| A weighted sound power | L _{WA} =64dB, K _{WA} =3dB | |
| A weighted sound pressure | L _{PA} =56dB, K _{PA} =3dB | |
| Waterproof | LUBA Machine: IPX6 Charging Station: IPX6 RTK Station: IPX7 | |
| Rain Detection | YES | |
| Weight | 17.65 kg/38.9 lbs. | 17.12 kg/37.7 lbs. |
| Size (L x W x H) | 69 x 51 x 27 cm/27.2 x 20.2 x 10.7 in. | |

Table 6- 2 H Version Specifications

| H Version (Cutting Height: 55-100 mm/2.2-4 inches) | | | | |
|--|--------------------------------------|--------------------------------------|--------------------------------------|--------------------------------------|
| Specifications | LUBA 2 AWD | | | |
| | 10000H | 5000H | 3000H | 1000H |
| Max. Mowing Size | 10,000 m ² / 2.5 acres | 5,000 m ² / 1.25 acres | 3,000 m ² / 0.75 acres | 1,000 m ² / 0.25 acres |
| In-App Area Storage Capacity | 12,000 m ² / 3 acres | 6,000 m ² / 1.5 acres | 3,500 m ² / 0.9 acres | 1,200 m ² / 0.3 acres |
| Max. multi-zone Management | 60 | 30 | 20 | 10 |
| Engine | All-wheel Drive (AWD) | | | |
| Max. Climbing Ability | 80% (38.6°) | | | |
| Max. Slope at the Edge | 45% (24°) | | | |
| Vertical Obstacle Passing Ability | 80 mm/3.1 in. | | | |
| Cutting Width | 40 cm/15.7 in. | | | |
| In-App Cutting Height Adjustment | 55-100 mm/2.2-4 in. | | | |
| Charging Time | 150 min | | | 90 min |

| H Version (Cutting Height: 55-100 mm/2.2-4 inches) | | |
|---|---|-------------------|
| Mowing Time per Charge | 180 min | 120 min |
| Auto-recharge | YES | |
| Positioning & Navigation | 3D Vision & RTK | |
| Obstacle Avoidance | 3D Vision & Ultrasonic Radar & Physical Bumper | |
| Voice Control | Alexa & Google Home | |
| Vision Monitoring | YES | |
| Connectivity | 4G & Bluetooth & Wi-Fi | |
| Noise Level | 60 dB | |
| A weighted sound power | L _{WA} =66dB, K _{WA} =3dB | |
| A weighted sound pressure | L _{PA} =58dB, K _{PA} =3dB | |
| Waterproof | LUBA Machine: IPX6 Charging Station: IPX6 RTK Station: IPX7 | |
| Rain Detection | YES | |
| Weight | 18 kg/39.8 lbs. | 17.5 kg/38.6 lbs. |
| Size (L x W x H) | 70 x 51 x 30 cm/27.2 x 20.2 x 12 in. | |

Table 6- 3 Battery Specifications

| Parameters | Specifications |
|---|---|
| Battery charger | GQ180-250700-E4 Input: 100-240V~, 50/60Hz, 2.5A Output: 25.2Vdc, 7.0A, 176.4W |
| Battery pack | Battery pack for 10000, 5000, 3000, 10000H, 5000H, and 3000H: 21.6Vdc, 9.6Ah Battery pack for 1000 and 1000H: 21.6Vdc, 4.5Ah |
| Temperature range for charging is 4-45 °C / 39-113 °F. | |
| WARNING: For the purposes of recharging the battery, only use the detachable supply unit provided with this appliance. | |

6.2 LED Indicator Codes

Table 6- 4 Luba's Indicator Description

| Indicator | Status | Description |
|--------------------------------|---------------------|---|
| Side Indicator | Constant red | <ul style="list-style-type: none"> ● System initialization ● Manual control mode ● Automatic work mode ● Charging finished (Luba still on the charging station) |
| | Breathing red | OTA upgrade in progress |
| | Slow flash red | <ul style="list-style-type: none"> ● Emergency stop activated ● Charging in progress |
| | Fast flash red | <ul style="list-style-type: none"> ● Low battery ● Bumper triggered ● Luba got stuck ● RTK positioning failed ● Luba has been lifted/tilted/flipped over |
| | Very fast flash red | <ul style="list-style-type: none"> ● System upgrade failed ● Systematic error |
| | Off | <ul style="list-style-type: none"> ● Pause ● Standby ● Sleeping |
| Front Indicator | Green | Power on |
| | Off | Power off |
| Vision Module Indicator | Constant green | RTK positioning is working well. |
| | Flash green | The RTK positioning has failed, but the vision positioning is working well. |
| | Constant red | Both RTK and vision positioning have failed. |
| | Flash blue | Luba's firmware is being upgrading. |
| | Constant blue | Luba powered on successfully. |

Table 6- 5 Charging Station's Indicator Description

| Indicator | Status | Description |
|-----------------------------------|---------------|-------------------------------------|
| Charging Station Indicator | Flash green | Luba is being charging. |
| | Green | Luba is fully charged or uncharged. |
| | Red | An error has occurred. |

Table 6- 6 RTK Reference Station Indicator Description

| Indicator | Status | Description |
|--|------------------|--|
| RTK Reference Station Indicator | Flash blue | The reference station is powering on. |
| | Flash green | The reference station is initializing. |
| | Green | The initialization is finished and the reference station works well. |
| | Off | The initialization is finished and the local time is between 18:00 and 8:00. |
| | Red | An error has occurred. |
| | Slow flash green | Low power consumption. |

6.3 Fault Codes

The app notification displays common fault codes along with their causes and troubleshooting steps. Here lists the most common issues.

| Fault Codes | Causes | Solutions |
|-------------|---|--|
| 316 | The left cutting disk motor is overheating. | The machine will return to normal once the motor has cooled down. This process may take several minutes. |
| 318 | The sensor for the left cutting disk motor has failed. | Restart Luba. If the issue persists after a few times of restart, contact the after-sale team. |
| 323 | The right cutting disk motor is overloaded. | Check if the cutting disk is jammed and clear it if necessary. Alternatively, raise the cutting height. |
| 325 | The right cutting disk motor fails to start. | Check whether the cutting disk is jammed. If not, restart Luba. If the issue persists after a few times of restart, contact the after-sale team. |
| 326 | The right cutting disk motor is overheating. | Restart Luba. If the issue persists after a few times of restart, contact the after-sale team. |
| 328 | The sensor for the right cutting disk motor has failed. | Restart Luba. If the issue persists after a few times of restart, contact the after-sale team. |
| 1005 | Low battery | Luba will continue working after the battery is charged to 80%. |
| 1300 | The positioning status is poor. | Await Luba's repositioning. |
| 1301 | The charging station has been moved. | Relocate the charging station. |
| 1420 | Timeout occurred while retrieving wheel speed data. | Restart Luba. If the issue persists, contact the after-sale team. |

| Fault Codes | Causes | Solutions |
|--------------------|---|--|
| 2713 | Charging has been stopped due to low battery voltage. | Restart Luba. If the issue persists after a few times of restart, contact the after-sale team. |
| 2726 | The battery is overcharged. | Stop charging immediately. If overcharging occurs frequently, contact the after-sale team. |
| 2727 | The battery is over discharged. | Recharge Luba. |

7 Warranty

Mammotion Technology Co., Ltd warrants that this product will be free from material and workmanship defects under normal use in accordance with the product materials published by Mammotion during the warranty period. The published product materials include but not limited to user manual, quick start guide, maintenance, specifications, disclaimer, in-app notifications, etc. The warranty period varies among different products and parts. Check the table below:

| Component | Warranty |
|------------------------------|------------------|
| Battery | 2 Years |
| Front/Rear Axel | |
| Wheel Hub Motor | |
| GPS Kit | |
| Vision Module | |
| PCBA | |
| RTK Reference Station | |
| Charging Station | |
| Decoration Parts | |
| Cutting Blade | Consumable Parts |
| Tire | No warranty |
| Cutting Disk | |

If the product does not function as warranted during the warranty period, please contact Mammotion customer service for instructions.

- For products purchased from a local dealer, kindly reach out to the dealer first.
- Users must present a valid proof of purchase, receipt, or order number (for Mammotion Direct Sales).

The Serial Number of the product is crucial for initiating warranty service.

- Mammotion will make every effort to address concerns through phone calls, email, or online chat.
- In some cases, Mammotion may advise you to download or install specific software updates.
- If issues persist, you may need to send the product to Mammotion for further assessment or to a local Mammotion-appointed service center.
- The warranty period for the product commences from the original date of purchase indicated on the sales receipt or invoice.
- For pre-ordered products, the warranty period begins from the shipping date from the local warehouse.
- Mammotion will need users to arrange the shipment by themselves if users would like to send the products to local service center or Mammotion factory for further diagnosis. Mammotion will repair or replace and send back to users at no cost if the problem falls under the warranty. If not, Mammotion or designated service center may charge a fee accordingly.

Here puts some examples of faults that warranty will not cover:

- Failure to follow the instructions outlined in the user manual.
- If the product arrives damaged during shipment and is not rejected upon delivery, or if no official documentation confirming the damages is provided by the shipping company. Inability to provide evidence of damage occurring during transit.
- Product malfunction due to accidents, misuse, abuse, natural disasters like floods, fires, earthquakes, exposure to food or liquid spills, incorrect electrical charging, or other external factors.
- Damage resulting from using the product in ways not permitted or intended as specified by Mammotion.
- Modification of the product or its components that significantly alters functionality or capabilities without obtaining written permission from Mammotion.
- Loss, damage, or unauthorized access to your data.
- Signs of tampering or alteration on product labels, serial numbers, etc.
- Failure to provide a valid proof of purchase from Mammotion, such as a receipt or invoice, or if there are suspicions of forgery or tampering with the documentation.

8 Compliance

FCC Compliance Statements

This device complies with Part 15 of the FCC Rules. Operation is subject to the following two conditions: (1) this device may not cause harmful interference, and (2) this device must accept any interference received, including interference that may cause undesired operation.

Caution: Changes or modifications not expressly approved by the party responsible for compliance could void the user's authority to operate the equipment.

Note: This equipment has been tested and found to comply with the limits for a Class B digital device, pursuant to Part 15 of the FCC Rules. These limits are designed to provide reasonable protection against harmful interference in a residential installation. This equipment generates, uses and can radiate radio frequency energy and, if not installed and used in accordance with the instructions, may cause harmful interference to radio communications. However, there is no guarantee that interference will not occur in a particular installation.

If this equipment does cause harmful interference to radio or television reception, which can be determined by turning the equipment off and on, the user is encouraged to try to correct the interference by one or more of the following measures:

- Reorient or relocate the receiving antenna.
- Increase the separation between the equipment and receiver.
- Connect the equipment into an outlet on a circuit different from that to which the receiver is connected.
- Consult the dealer or an experienced radio/TV technician for help.

ISED Compliance Statements

This device contains licence-exempt transmitter(s)/receiver(s) that comply with Innovation, Science and Economic Development Canada's licence-exempt RSS(s). Operation is subject to the following two conditions:

(1) This device may not cause interference.

(2) This device must accept any interference, including interference that may cause undesired operation of the device.

This equipment complies with IC RSS-102 radiation exposure limits set forth for an uncontrolled environment.

L'émetteur/récepteur exempt de licence contenu dans le présent appareil est conforme aux CNR d'Innovation, Sciences et Développement économique Canada applicables aux appareils radio exempts de licence.

L'exploitation est autorisée aux deux conditions suivantes:

(1) L'appareil ne doit pas produire de brouillage;

(2) L'appareil doit accepter tout brouillage radioélectrique subi, même si le brouillage est susceptible d'en compromettre le fonctionnement.

Cet équipement est conforme aux limites d'exposition aux radiations IC CNR-102 établies pour un environnement non contrôlé.

RF Exposure Compliance

This equipment complies with FCC/IC RSS-102 radiation exposure limits set forth for an uncontrolled environment. This transmitter must not be co-located or operating in conjunction with any other antenna or transmitter. This equipment should be installed and operated with minimum distance 20 cm between the radiator and your body.

Cet équipement est conforme aux limites d'exposition aux radiations IC CNR-102 établies pour un environnement non contrôlé.

Cet émetteur ne doit pas être colocalisé ou fonctionner en conjonction avec une autre antenne ou un autre émetteur. Cet équipement doit être installé et utilisé avec une distance minimale de 20 cm entre le radiateur et votre corps.

This radio transmitter [IC: 29682-RTK0002] has been approved by Innovation, Science and Economic

Development Canada to operate with the antenna types listed below, with the maximum permissible gain indicated. Antenna types not included in this list that have a gain greater than the maximum gain indicated for any type listed are strictly prohibited for use with this device.

Cet émetteur de radio [IC: 29682-RTK0002] a été approuvé par innovation, sciences et développement économique Canada pour l'utilisation des types d'antennes énumérés ci - dessous avec les gains maximaux admissibles indiqués. Les types d'antennes qui ne sont pas inclus dans cette liste et dont le gain est supérieur au gain maximal de l'un des types énumérés sont strictement interdits pour une utilisation avec cet appareil.

Dipole Antenna 3.26dBi, 50Ω

Luba 2 AWD RTK Reference Station

EC/EU DECLARATION OF CONFIRMITY

Manufacturer: Mammotion Technology Co., Limited

Address: UNIT 89 3/F YAU LEE CENTRE NO.45 HOI YUEN ROAD, KWUN TONG KL

Authorised Representative: WSJ Product Ltd.

Address: Eschborner Landstraße 42-50, 60489 Frankfurt am Main, Germany

The name and address of person authorized to compile the technical file: WSJ Product Ltd, Eschborner Landstraße 42-50, 60489 Frankfurt am Main, Germany.

Herewith declares that the Machinery:

Generic Designation: Robotic Lawnmower

Product Name: LUBA 2 AWD

Type / Model(s): 1000, 3000, 5000, 10000, 1000H, 3000H, 5000H, 10000H

Described as: Robotic Lawnmower for Grass Cutting

Cutting Width: 400mm Power: 97.2Wh / 207.36Wh

Complies with the following Directives,

2006/42/EC

2014/53/EU

ROHS 2.0

Standards conform to,

EN 60335-1:2012+A11:2014+A13:2017+A1:2019+A2:2019+A14:2019+A15:2021,

EN 50636-2-107:2015+A1:2018+A2:2020+A3:2021

Article 3.1a:

EN IEC 62311:2020

EN IEC 62368-1:2020+A11:2020

Article 3.1b:

EN IEC 61000-6-1:2019

EN IEC 61000-6-3:2021

EN 61000-3-3: 2013+

A1:2019+A2:2021

EN IEC 61000-3-2: 2019+A1:2021

EN 301 489-1 V2.2.3

EN 301 489-3 V2.3.2

EN 301 489-17 V3.2.4

EN 301 489-19 V2.2.1

EN 301 489-52 V1.2.1

Article 3.2:

EN 300 220-1 V3.1.1

EN 300 220-2 V3.2.1

EN 300 328 V2.2.2

EN 303 413 V1.2.1

EN 301 893 V2.1.1

EN 300 440 V2.2.1

EN 301 511 V12.5.1

EN 301 908-1 V15.2.1

EN 301 908-2 V13.1.1

EN 301 908-13 V13.2.1

IEC 62321-3-1:2013

IEC 62321-5:2013

IEC 62321-4:2013+A1:2017

IEC 62321-7-1:2015

IEC 62321-7-2:2017

IEC 62321-6:2015

IEC 62321-8:2017

ISO 18219:2015

Signed for and on behalf of: Mammotion Technology Co., Limited

Signed: Roland Huang

Name: Roland Huang

Date: 29/11/2023

Position: Product manager

Place: Shenzhen, China





MAMMOTION Technology CO., LTD

www.mammotion.com

Copyright © 2024, MAMMOTION All Rights Reserved.